



## **COMPACT APC10 DALI-2**

Ceiling-mounted presence detector  
with integrated control unit  
for DALI-2 devices

**User manual**

| MA01994300 | V1.00 | 20220812 | EN |

<b>Document</b>	<b>Version</b>	<b>Edition</b>	<b>Comment</b>
MA01994300	V1.00	20220812	Initial version F V1.1.1   A V1.8.4

---

© ESYLUX GmbH  
An der Strusbek 40 | 22926 Ahrensburg | Germany

Subject to change without notice.

Reproductions, including translations into other languages or reuse of content for other purposes, may only be authorised by written consent from ESYLUX GmbH.

**Table of contents**

<b>1</b>	<b>Introduction.....</b>	<b>5</b>
1.1	Manufacturer/Contact.....	5
1.2	Product identification.....	5
1.3	Content and meaning of the document .....	6
1.4	Typographical conventions .....	7
<b>2</b>	<b>Safety.....</b>	<b>8</b>
2.1	Intended use .....	8
2.2	Staff qualifications .....	8
2.3	Safety instructions.....	8
<b>3</b>	<b>Overview .....</b>	<b>10</b>
3.1	Scope of delivery .....	10
3.2	APC technical data .....	10
3.3	System overview .....	14
3.4	Features and advantages of the APC .....	15
3.5	Features and advantages of the app.....	15
3.6	Declaration of conformity.....	16
3.7	Accessories .....	16
<b>4</b>	<b>Installation .....</b>	<b>17</b>
4.1	Mechanical work.....	17
4.2	Circuit diagram.....	18
4.3	Electrical work.....	18
4.4	Installing the app .....	23
4.5	Initial commissioning.....	24
<b>5</b>	<b>Configuration.....</b>	<b>26</b>
5.1	APC basics.....	26
5.1.1	Broadcast mode.....	26
5.1.2	Group operation .....	27
5.1.3	Open-loop light control - Closed-loop light control .....	28
5.1.4	Minimum constellations .....	29
5.1.5	APC LED indicators.....	31
5.1.6	BlueMode .....	32
5.2	App basics .....	33
5.2.1	Home screen .....	33
5.2.2	Menu structure .....	34
5.2.3	Using the app.....	36
<b>6</b>	<b>Settings menu.....</b>	<b>39</b>

<b>7</b>	<b>Products section</b> .....	<b>42</b>
7.1	Products .....	42
7.2	Bluetooth connection .....	44
7.3	Setup Wizard .....	46
7.4	Setup Wizard .....	46
7.5	Manual setup .....	51
7.6	Address .....	52
7.7	Create groups .....	54
7.8	Configure groups .....	56
	7.8.1 Operating mode .....	58
	7.8.2 Light .....	61
	7.8.3 Afterglow .....	69
	7.8.4 Orientation light .....	71
7.9	Scenes .....	73
7.10	Group offset .....	75
7.11	Change over groups .....	79
7.12	Parameterise devices .....	85
	7.12.1 Control gear (lighting) .....	86
	7.12.2 Motion sensors .....	86
	7.12.3 Light sensors .....	88
	7.12.4 Push-button .....	89
	7.12.5 Switch .....	93
	7.12.6 Actuators .....	95
<b>8</b>	<b>Projects section</b> .....	<b>97</b>
<b>9</b>	<b>Menu information</b> .....	<b>98</b>
<b>10</b>	<b>FAQ</b> .....	<b>100</b>
	10.1 What does this APC indicator mean? .....	100
	10.2 What does this app indicator mean? .....	100
<b>11</b>	<b>Decommissioning</b> .....	<b>101</b>
	11.1 Disassembly .....	101
	11.2 Disposal .....	101
<b>12</b>	<b>APPENDIX</b> .....	<b>102</b>
	12.1 Abbreviations .....	102
	12.2 Glossary .....	103



# 1 Introduction

## 1.1 Manufacturer/Contact

If you have questions about the product, need help with the app or are planning extensions, do not hesitate to get in touch with us:

ESYLUX GmbH  
 An der Strusbek 40  
 22926 Ahrensburg  
 Germany

Phone: +49 4102 489-0  
 E-mail: [info@esylux.com](mailto:info@esylux.com)  
 Internet: [www.esylux.com](http://www.esylux.com)

## 1.2 Product identification

This document applies to the following products:

Item name	A	B	C	H	H <sub>max</sub>	Item number
PD-C 360bt/8 APC10 PS plus DALI-2	8	6	4	3	5	EP10428142
PD-C 360bt/24 APC10 PS plus DALI-2	24	11	8	3	10	EP10428159
PD-C 360bt/32 APC10 PS plus DALI-2	32	11	8	3	10	EP10428265

A: Detection range transverse  $\varnothing$  [m]  
 B: Detection range frontal  $\varnothing$  [m]  
 C: Presence range  $\varnothing$  [m]  
 H: recommended mounting height [m]  
 H<sub>max</sub>: maximum mounting height [m]

Detection ranges of the presence detector:

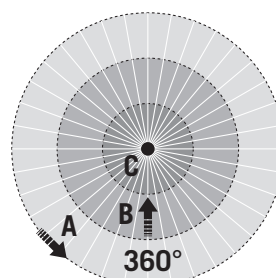

The name of the item contains important information about the product:

Element of the item name	Meaning
PD	Presence Detector device category
C	Compact series
360	Detection angle (in degrees)
bt	Configuration via Bluetooth and app
8/24/32	Detection range transverse ( $\varnothing$ in meters)
APC10	Application Controller Variant
PS	Including power supply
plus	with HVAC contact
DALI-2	DALI-2 control system

### 1.3 Content and meaning of the document

This document contains detailed information about the installation, configuration and complex functions of the product.

The current document is available for download as a PDF at [www.esylux.com](http://www.esylux.com). It can be printed out if required.

- Read the document before using the product.
- Pay particular attention to the safety and warning instructions.
- If you have any questions, contact the manufacturer.
- Keep the document in a safe place.
- If other people use the product, give this document to them.

## 1.4 Typographical conventions

The following typographical conventions are used in this document:

Typographical depiction	Meaning
<Factory settings>	Menu, screen, button
[Fully automatic]	Condition, parameters
"Connection established"	Message, input
see 2 <i>Safety</i>	Cross-reference to chapter or section
1. -	Binding sequence of actions
2. -	
3. -	
» -	Action result

The warnings in this document have the following meanings:

 **DANGER**

---

... warns of a hazard with a high degree of risk.  
Failure to observe will result in death or serious injury.

 **WARNING**

---

... warns of a hazard with a medium degree of risk.  
Failure to observe may result in death or serious injury.

 **CAUTION**

---

... warns of a hazard with a low degree of risk.  
Failure to observe may result in moderate or minor injury.

**NOTICE**

---

... warns of possible property damage.  
Failure to observe may result in damage to equipment or the environment.

In addition:

 **Information**

---

**Important or useful additional information**

## 2 Safety

### 2.1 Intended use

This product is a DALI-2 certified ceiling-mounted presence detector with integrated DALI-2 controller for room-wide light control of a maximum of 16 groups. Configuration is done via an app.

The product may only be used as follows:

- The product is intended exclusively for indoor use and ceiling mounting with fixed installation.
- The product is designed for the use DALI-2 components in the DALI-2 bus.
- The maximum number of DALI-2 components that can be connected and the operating conditions must be observed. For details see *3.2 APC technical data*.
- The use of unsuitable components, modifications to the product and unauthorised repairs are not permitted.
- The product may only be used if it is in technically fault-free condition.

In the event of improper use, the manufacturer generally excludes any resulting personal injury or property damage.

### 2.2 Staff qualifications

Installation, commissioning and other work on the 230 V mains may only be carried out by electricians or electrical specialists in keeping with the country-specific regulations.

Configuration and operation can also be performed by individuals with no electrical engineering qualification.

- If you need assistance with the configuration, contact an electrical fitter or a qualified electrician.

### 2.3 Safety instructions

Installation, commissioning and other work on the 230 V mains may only be carried out by electricians or electrical specialists in keeping with the country-specific regulations.

The connection must be protected with a 10 A circuit breaker.

Nevertheless, there are the following residual risks:

**WARNING**

**Risk of fatal injury from electric shock.**

Working on the 230 V mains can result in death or serious injury.

- Always observe the 5 safety rules:
  1. Switch off.
  2. Secure against being switched on again.
  3. Make sure that no voltage is present.
  4. Earth and short-circuit.
  5. Cover adjacent live parts.

**WARNING**

**Risk of fatal injury from interfering with the device.**

Opening and modifying the device can result in death or serious injury – also for any others working on the system.

- Only remove the connection cover of the Powerbox for installation.

**CAUTION**

**Risk of injury due to improper installation.**

When inserting the device into the installation opening, the raised mounting springs may snap back.

- Do not release the mounting springs before inserting them into the installation opening.

**NOTICE**

**Risk of damage due to faulty connection.**

Reversed polarity or short circuit of the bus line can result in malfunctions or damage to the components.

- Observe the DALI-2 specifications (IEC 62386).
- Only use bus cables (not included) for all DALI-2 connections in accordance with DALI-2 specifications.

**NOTICE**

**Risk of damage due to improper cleaning.**

Cleaning with alcoholic, corrosive or abrasive cleaning agents or scouring pads can damage the surface and lens of the device and cause malfunctions.

- Use a soft cloth dipped in detergent solution for cleaning.

## 3 Overview

### 3.1 Scope of delivery

The product scope of delivery comprises:

- Device
  - Control unit (controller) with power supply (Powerbox)
  - Sensor unit with lens
  - 180° lens mask
- Cable tie for tension relief
- Brief instructions for installation and commissioning

### 3.2 APC technical data

APC10	
<b>General</b>	
Device category	Ceiling-mounted presence detector with integrated DALI-2 control unit and power supply
Control system	DALI-2 bus
Status signaling	Multicolour LEDs
User interface	ESY Control App
User interface	Bluetooth (BLE)
Bluetooth range approx.	10 m
Ambient temperature	0-40 °C
Relative humidity	5-93 %, non-condensing
Conformity	CE, EAC, RoHS, WEEE

**APC10**

<b>Mounting</b>	
Mounting type	Ceiling installation
Mounting location	Soundproof ceiling
Installation opening $\varnothing$	68 mm
Ceiling thickness max.	40 mm
Installation depth	80 mm + bending radius of installation cable
Connection type	Plug-in terminal
Connectable conductor cross-section	0.5-2.5 mm <sup>2</sup>
Stripping length	10 mm
Bus cable length max.	300 m (conductor cross-section $\geq 1.5$ mm <sup>2</sup> )
Cable length to a push-button/switch max.	30 m
<b>Housing</b>	
Outer diameter $\varnothing$	108 mm
Housing height	118 mm – 126 mm – 126 mm *
	* each for model /8 – /24 – /32
Weight	237 g
Material	UV-stabilised polycarbonate
Colour	white, similar to RAL 9010
Protection class	IP20
<b>Electrical version</b>	
Mains voltage	230 V AC $\pm 10$ %
Mains frequency	50-60 Hz
Starting current	20 A / 110 $\mu$ s
Power consumption	5.0 W
Power consumption max. DALI load	3.7 W
Standby consumption	<0.4 W
Protection class	II

<b>APC10</b>	
Control system/bus system	DALI-2 (IEC 62386)
DALI output voltage	16 V DC
External power supply possible	9.5-22.5 V DC
DALI guaranteed output current	240 mA
DALI maximum output current	250 mA
DALI no-load current	2 mA
DALI quiescent current input	1.9 mA
DALI start-up time	600 ms
Push-button/switch connections	4x (non-floating)
Push-button/switch connections, potential	230 V AC
Switch actuator connection	1x (potential-free)
Switch actuator connection, potential max.	250 V AC / 24 V DC
Switch actuator connection, current max.	10 A
<b>Motion sensor</b>	
Principle	Passive infrared (PIR)
Warm-up time	25 s
Detection angle	360°
Detection range transverse $\varnothing$	8 m – 24 m – 32 m *
Detection range frontal $\varnothing$	6 m – 11 m – 11 m *
Presence range detection range $\varnothing$	4 m – 8 m – 8 m *
Max. detection area	50 m <sup>2</sup> – 452 m <sup>2</sup> – 804 m <sup>2</sup> *
Recommended mounting height	3 m – 3 m – 3 m *
Maximum mounting height	5 m – 10 m – 10 m *
	* each for model /8 – /24 – /32
Range adjustment	mechanically, by means of cut-to-size lens mask
<b>Light sensor</b>	
Light measurement	Mixed light
Brightness range	5-2000 lx



APC10

Functionality	
Configurable bus participants max.	64
Configurable groups max.	16
Configurable scenes max.	16
Operating mode	Fully automatic, semi-automatic, manual operation
Constant light control	+
Group offset	+
Manual adjustment of brightness setpoint	+
Afterglow	+
Orientation light	+
Flexible group switching	+
Switching of external lighting and HVAC	+
Timer function	-
Automatic dimming control	-
Staircase lighting function	-
Power cut-off	-
Swarm function	-
Central function	-
HCL/ SymbiLogic	-
Night operation	-
Alarm operation	-

### 3.3 System overview

Example connection diagram for an APC application with a BMS:

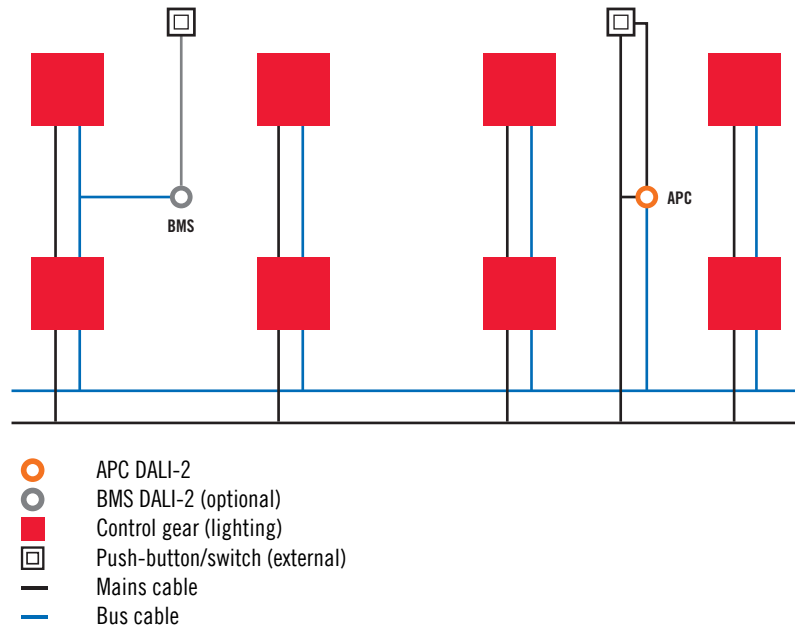

DALI-2 bus participants and bus communication between APC and BMS:

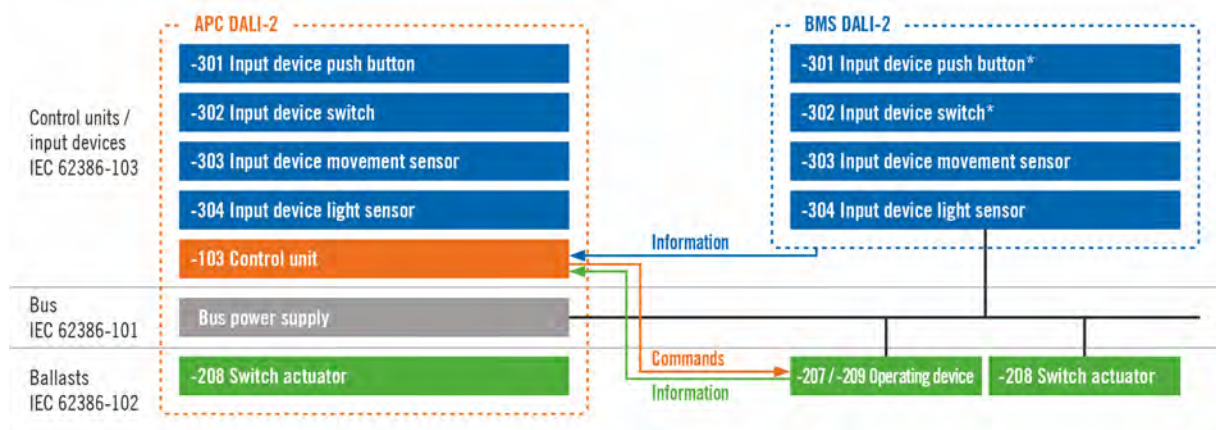

-101 - -304 Standards part of IEC 62386  
 \* Not available in model COMPACT MINI BMS DALI-2

### 3.4 Features and advantages of the APC

The APC offers the following features and applications:

- DALI-2 certified ceiling-mounted presence detector with integrated DALI-2 control unit and power supply
- Presence and daylight-dependent constant light control for maximum energy efficiency
- Room-wide lighting control of up to 16 groups
- Wide range of manual override options and up to 16 scenes
- Easy adaptation to individual and complex room situations
- Automatic switching of groups when room use changes
- Fast start-up with factory settings in broadcast mode
- Individual groups immediately ready for operation with factory settings
- Status signaling by multicolour LEDs for all operating states and sensor actions
- 4 inputs for external push-buttons/switches (non-floating)
- Relay for switching external lighting and HVAC (max. 10 A)

### 3.5 Features and advantages of the app

The app offers the following features and applications:

- Simple and comprehensive configuration of the APC via the bidirectional Bluetooth interface
- No internet access required for all relevant configuration steps
- Clear menu with self-explanatory structure and comprehensible operating elements
- Setup wizard and practical user guidance through the entire configuration process
- Context-dependent information texts and explanatory diagrams for most menu items
- Situation-dependent feedback for missing information or impossible combinations
- Simple administration and documentation of configured projects as PDF reports
- Free download and regular updates via your app store

### 3.6 Declaration of conformity

We, the company ESYLUX GmbH, hereby declare that the product complies with the following requirements:

- Directive 2014/53/EU (Radio Equipment Directive)
- Directive 2011/65/EU (RoHS Directive)

The complete document is available for download as a PDF file:  
[https://www.esylux.com/ce/esylux\\_ce\\_pd-c\\_dali-2\\_apc\\_ce01994400.pdf](https://www.esylux.com/ce/esylux_ce_pd-c_dali-2_apc_ce01994400.pdf)

In the event of modification or extension of the product not agreed with us, this declaration shall lose its validity.

### 3.7 Accessories

The following accessories are available for this product:

Item name	Description	Item number
COMPACT Cover Set 24/32 SR	Cover set for COMPACT series, 24 m/32 m, consisting of cover panel and design ring, silver	EP10425431
COMPACT Cover Set 24/32 BK	Cover set for COMPACT series, 24 m/32 m, consisting of cover panel and design ring, black	EP00007491
Basket Guard Round Large	Basket guard for presence and motion detectors as well as smoke detectors, diameter 180 mm, height 90 mm	EM10425608

## 4 Installation

### 4.1 Mechanical work

#### Description

The device is intended for mounting in the ceiling panel of a suspended ceiling.

#### Requirements

- The mains cable and the DALI-2 bus cable as well as any cables of external push-buttons/switches and switch actuator components have been prepared.
- There are no cables in the mounting area that could be damaged during drilling.
- The installation dimensions shown can be adhered to.

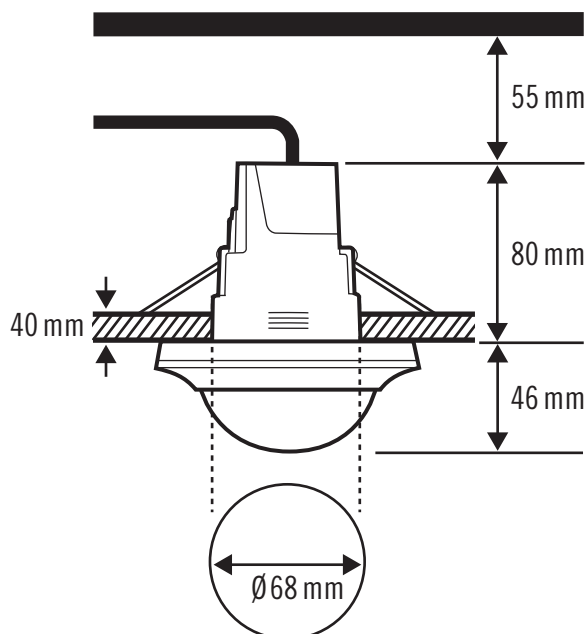

The required clearance above the Powerbox depends on the bending radius of the installation cables (example: 55 mm).

#### Procedure

1. Drill the installation opening in the ceiling panel.
2. Guide the installation cables downwards through the installation opening.

It is best to insert the device into the installation opening only after the installation lines have been connected.

## 4.2 Circuit diagram

Example circuit diagram for an APC application:

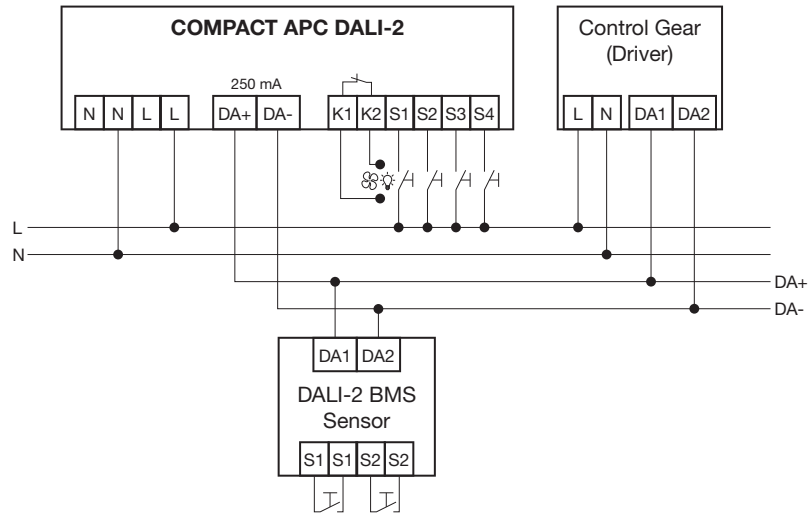

<b>COMPACT APC DALI-2</b>	APC DALI-2
L/N	Mains (230 V AC)
DA+/DA-	DALI-2 bus
K1/K2	External switch actuator component (floating)
S1-S4	External push-buttons/switches (non-floating)
<b>Control Gear (Driver)</b>	Example of a DALI control gear (lighting)
DA1/DA2	DALI-2 bus
<b>DALI-2 BMS Sensor</b>	Example of a BMS DALI-2
DA1/DA2	DALI-2 bus
S1/S2	External push-buttons/ switches (floating)

## 4.3 Electrical work

### Requirements

#### **⚠ WARNING**

#### **Risk of fatal injury from electric shock.**

Working on the 230 V mains can result in death or serious injury.

- Always observe the 5 safety rules:
  1. Switch off.
  2. Secure against being switched on again.
  3. Make sure that no voltage is present.
  4. Earth and short-circuit.
  5. Cover adjacent live parts.

**Procedure**

1. Remove the connection cover from the Powerbox. Loosen the screws as shown in the illustration.

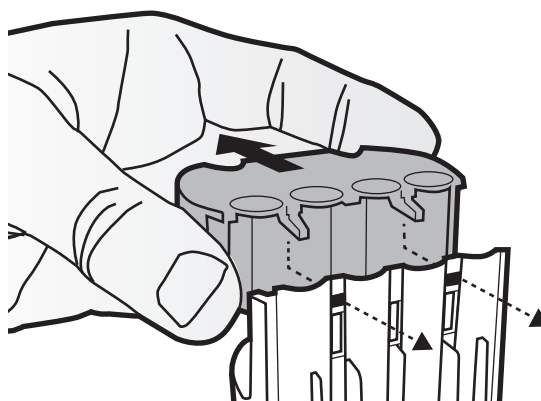
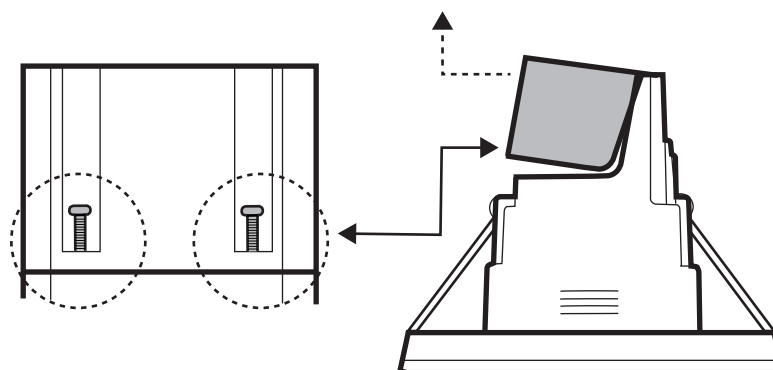

2. Remove the covers in the connection cover at the points where cables are to be fed through.

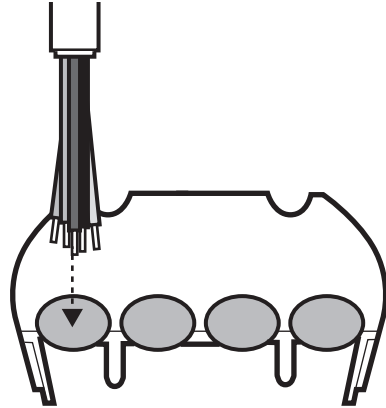

3. Remove the insulation on each of the sheathed cables and the individual wires.

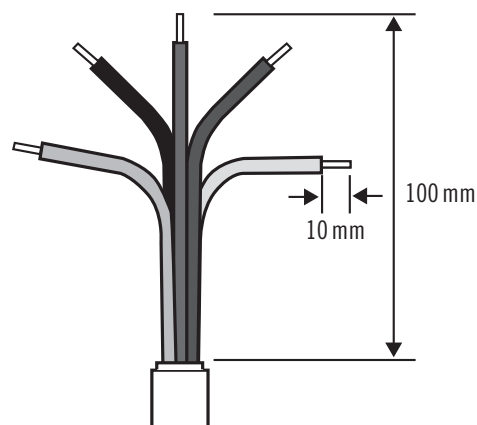

4. Take note of the order in which they are connected:
  - **A:** If external push-buttons/switches (on S1-S4) or switch actuator components (on K1/K2) are used, connect these lines first.
  - **B:** Connect the DALI-2 bus cable (to DA+/DA-).
  - **C:** Connect the mains cable (to L/N).



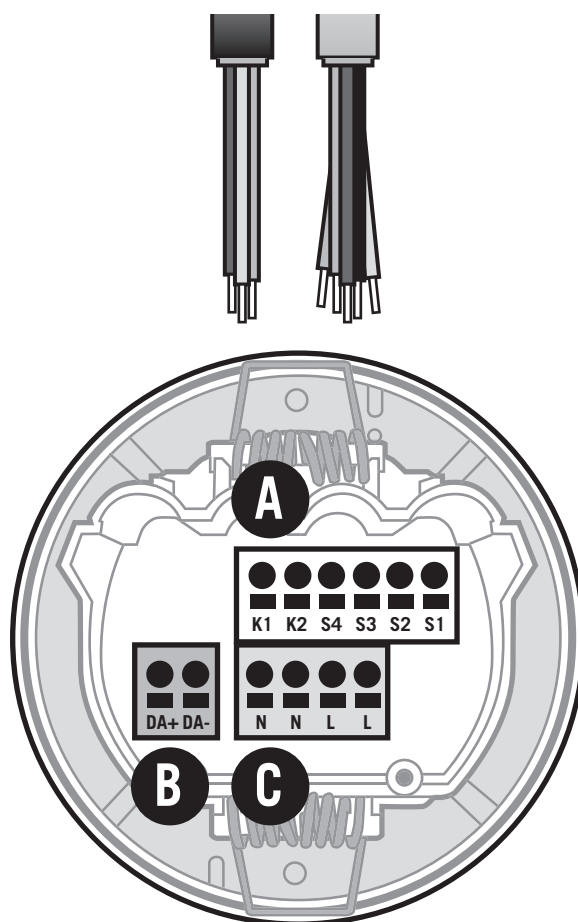

5. If necessary, route a protective earth conductor via a separate terminal.

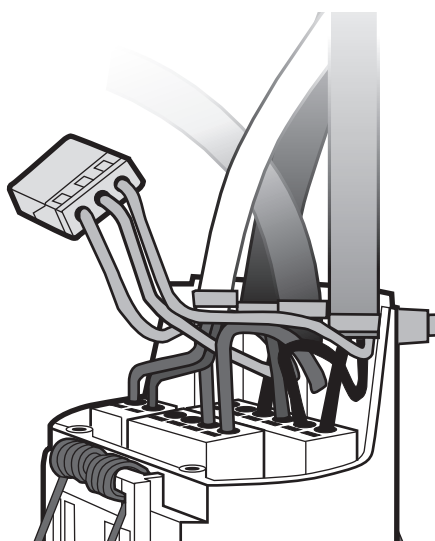

6. Use the included cable ties to secure the cables to the Powerbox for strain relief.

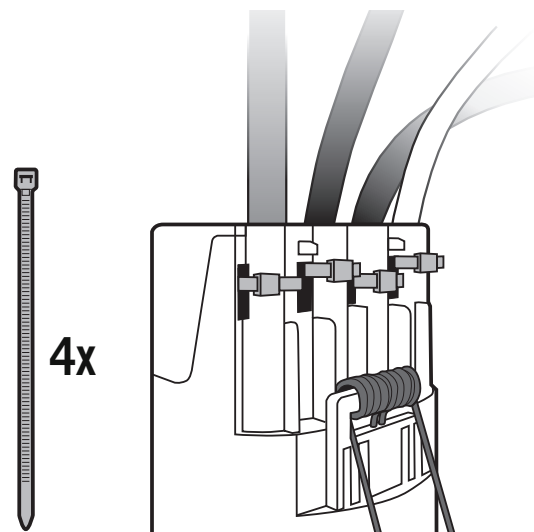

7. Put the connection cover back on the Powerbox and screw it tight.
8. Write down the PIN code on the sticker on the device. You will need the PIN code later to register the device in the app. You can also remove the sticker and affix it to your project documents.

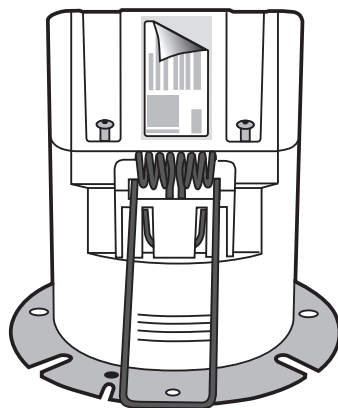

9. Insert the device - with the mounting springs folded up - into the installation opening.  
**CAUTION!** Risk of injury due to improper installation. When inserting the device into the installation opening, the raised mounting springs may snap back. Do not release the mounting springs before inserting them into the installation opening.

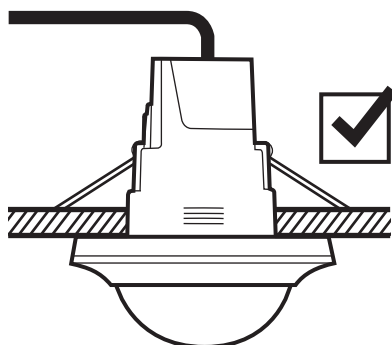

- » The mounting springs spread above the ceiling panel; this fixes the device in place.

10. If necessary, use the 180° lens mask.

Unscrew the lens opening (bayonet catch) and remove it. Put the lens mask on the sensor unit, put the lens opening back on and screw it tight.

## 4.4 Installing the app

### Description

To use the app, you need a Bluetooth-enabled mobile device (smartphone or tablet) and an account at the relevant app store (Google Play Store or Apple App Store).

PRIVACY NOTICE: The data used by the app is not stored or reused outside the mobile device.

NOTE: The exact name of the settings below may differ depending on the Android or iOS version.

### Requirements

Android

- Operating system: Android 6.0 or later
- Activate/allow system settings:
  - Bluetooth (BLE 5.0)
  - Wi-Fi or mobile data
- Grant app permissions:
  - Location
  - Camera(s)
  - Memory

### Apple iOS

- Compatible with
  - iPhone: iOS 11.0 or later
  - iPad: iOS 11.0 or later
- Activate/allow system settings:
  - Bluetooth (BLE 5.0)
  - Wi-Fi or mobile data
- Grant app permissions:
  - Location
  - Camera(s)
  - Memory

### Procedure

- Download the <ESY Control> app from your app store.
- Install and open the app.

NOTE: The app is being continuously improved, meaning that new versions (updates) will be available in future.

- For Android mobile devices, you can set whether updates are automatically applied when the app is started or whether you have to update the app manually in the app store.
- For Apple iOS mobile devices, you can check the app store to see if an update is available and then update the app manually.

## 4.5 Initial commissioning

### Description

After completion of the mechanical and electrical work, initial commissioning should be carried out as a functional test.

### Requirements

- Connecting the mains voltage poses no risk.
- The <ESY Control> app is installed.  
For details see *4.4 Installing the app*.
- The app has been started.  
For details see *5.2.3 Using the app*.

### Procedure

- Switch on the mains voltage for this circuit.
- Wait approx. 30 s until the APC is ready for operation.
- Establish the Bluetooth connection between the app and the APC.  
For details see *7.2 Bluetooth connection*.

If the connection works:

- The Setup Wizard shows the options for configuring the APC.

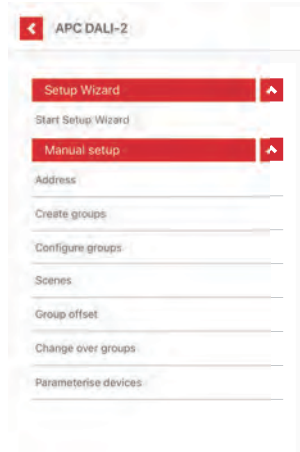

### Future steps

- You can now configure the APC.  
For details see *7.3 Setup Wizard*.
- If you exit the Setup Wizard at this time, the APC will remain in broadcast mode.  
For details see *5.1.1 Broadcast mode*.

## 5 Configuration

### 5.1 APC basics

#### 5.1.1 Broadcast mode

##### Description

Broadcast mode is the unconfigured factory setting. This enables e.g. a quick commissioning of a simple lighting system without having to address bus participants or divide them into groups.

- There are no restrictions in the choice of operating mode.
- All bus participants communicate via a common signal.
- All control gear (lighting) are controlled in the same way.
- All input devices have the same rights. For example, presence detection of each presence detector instance has the same effect on the lighting. The same applies to push-button instances, for example.
- Creating a group automatically ends broadcast mode.

##### App

There are two ways to use the broadcast mode.

a.: Non-addressed operation (during initial commissioning and after resetting to factory settings)

- It is not necessary to address the bus participants.
- Individual parameterisation of individual bus participants is not possible.
- Light control is only managed by APC's light sensor. Other light sensors cannot be used.
- Otherwise, only presence detector and push-button inputs are taken into account.
- The standard push-button functions apply to connected push-buttons:

Short press of the button	Switch light on/off
Long press of the button	Dim light up/down
Double press of the button	Return to the original control

b.: Addressed mode (for quick set-up)

- Addressing bus participants is possible. Broadcast mode is maintained even after addressing – provided that no groups are set up.
- After addressing, the input devices can be set up individually.

- External light sensors (e.g. in a BMS) must be explicitly set up for each device, otherwise they are ignored.
- For connected push-buttons, the standard push-button functions (see above) can be changed by configuration.

Ending broadcast mode:

- Creating a group automatically ends broadcast mode.

Restoring broadcast mode:

- Deleting the last configured group automatically restores broadcast mode.

The last configuration saved for broadcast mode is used.

### Adjustable parameters

Separate parameter settings are possible for broadcast mode.

Parameter	Setting values	Default value
Brightness setpoint (for light control)	100-2000 lx	500 lx
Brightness switching value (for light control)	5-2000 lx	500 lx
Light output min.	0-100 %	0 %
Light output max.	0-100 %	100 %
Light output at start	10-100 % (in 10% steps)	50 %
Follow-up time	00:01 - 24:00	00:05
Follow-up time at manual light OFF	00:01 - 24:00	00:05

## 5.1.2 Group operation

### Description

Group operation allows the individual grouping of lights in a room zone. The room zones and their groups can be located in one room, but they can also be set up over several rooms.

- To create groups, all bus devices are addressed and assigned to their respective groups.
- Up to 16 groups can be set up. Each group has its own operating mode.  
For details see *7.8.1 Operating mode*.
- Group operation and broadcast mode are mutually exclusive.  
For details see *5.1.1 Broadcast mode*.
- Depending on the desired operating mode of a group, certain components must or can be present and configured in the corresponding group.  
For details see *5.1.4 Minimum constellations*.

- Group functions can be supplemented by the <group offset> function, which allows light control with fewer presence detectors. For details see 7.10 *Group offset*.
- Group functions can be supplemented by the <Change over groups> function, which allows light control to be adapted to changing room situations. For details see 7.11 *Change over groups*.

**Application example: Groups for room zones**

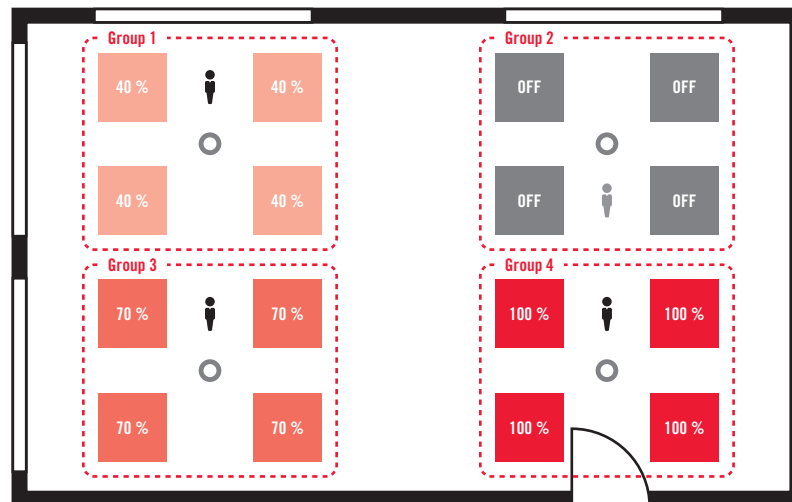

- Light fixture (illuminance in %)
- Presence detector (e.g. one APC DALI-2, three BMS DALI-2)
- 👤 Person present
- 👤 No person present

Explanation: Each presence detector provides individual, presence- and daylight-dependent light control in its room zone. If no one is present, as in group 2, the lighting remains switched off.

**5.1.3 Open-loop light control - Closed-loop light control**

**Description**

Basically, there are two ways the APC control can influence the lighting:

- **Open-loop control** (the standard case)  
 How it works: Lighting is regulated to a constant brightness level depending on the amount of daylight.  
 Relevant parameter: Brightness setpoint  
 Technical implementation: Brightness is continuously measured and compared to the brightness setpoint. Light output is continuously adjusted so that the difference between the measured brightness value and the brightness setpoint is minimised.



- If the measured brightness level falls permanently below the brightness setpoint when presence is continuously detected (plus follow-up time), the light is switched on and light output is continuously controlled.
- If the measured brightness level is permanently above the brightness setpoint, the light is switched off.
- **Closed-loop light control** (the special case)  
 How it works: Lighting is switched with a preset, adjustable light output.  
 Relevant parameter: Brightness switching value  
 Technical implementation: When open-loop light control is deactivated, the light is controlled to a defined light output.
  - If the measured brightness level falls permanently below the brightness switching value when presence is continuously detected (plus follow-up time), the light is switched on and controlled to the defined light output.
  - If the measured brightness level is permanently above the brightness switching value, the light is switched off.

**App**

Changing from automatic light control to light control is done in the <Light> menu. For details see 7.8.2 *Light*.

**Adjustable parameters**

Separate parameter settings apply for open-loop and closed-loop light control. For details see *Automatic light control*.

**5.1.4 Minimum constellations**

Depending on the operating mode of a group, the following devices/instances must or can be present and configured in this group:

Operating mode	Presence detector	Light sensor	Push-button	Switch	Actuator	Control gear (lighting)
Fully automatic	x	o	o	o	x*	x*
Semi-automatic	x	o	x	o	x*	x*
Manual operation	–	o	x	o	x*	x*

x Absolutely necessary  
 o Possible  
 – Without effect  
 \* Control gear or switching actuator component required

For details see 7.8.1 *Operating mode*.

**Explanations**

- When planning an operating mode, the required devices/instances must be physically installed and addressed in the bus. The device or one of its required instances must be assigned to the group.
- If a group is not assigned a light sensor, e.g. in an interior room, only closed-loop light control takes place.
- If the requirements for <semi-automatic> are met, you can also implement <fully automatic> or <manual operation>. The reverse is not true.
- If the requirements for an operating mode are not satisfied, not all parameter fields are available in parameter dialogues. This is an indication of missing devices/instances.
- If you change the operating mode, the parameters irrelevant to the new operating mode are retained. They become active again when you switch back.
- **IMPORTANT:** If you remove a required participant (device/instance) from the group, this group changes to the next possible operating mode. This can entail certain restrictions.

### 5.1.5 APC LED indicators

Various states and situations of the configuration can be identified by the colour and the flashing behaviour of the integrated LED.

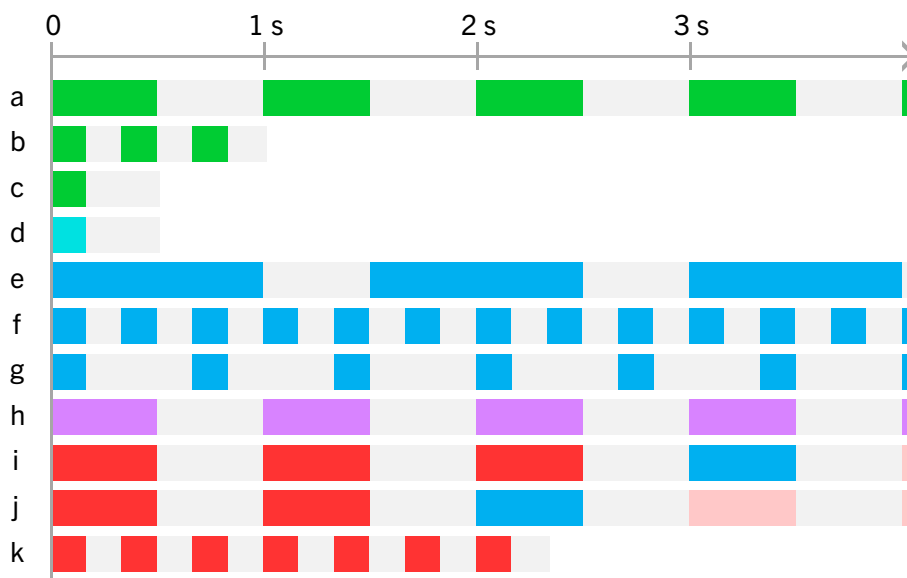

	Colour	Meaning
a	green	System starting (approx. 20 s)
b	green	Operation starting or BlueMode ending
c	green	Motion detected
d	turquoise	Motion detected, but motion sensor not assigned to a group
e	blue	BlueMode activated
f	blue	Software upload activated
g	blue	Bluetooth connection activated
h	purple	DALI-2 identification
i	red – blue	Error 0x31: RecoveryMode activated, software and Bluetooth deactivated <ul style="list-style-type: none"> <li>Briefly disconnect APC from the mains, then pair it with the mobile device (Bluetooth) and update the software.</li> </ul>
j	red – blue	Error 0x21: Bus voltage missing or short circuit in the bus cable <ul style="list-style-type: none"> <li>Check voltage supply in the bus.</li> </ul>
k	red	Reset to factory settings activated (approx. 2 s)

### 5.1.6 BlueMode

#### Description

BlueMode is the ESYLUX name for a special configuration state of the control. BlueMode works as follows:

- Open/closed-loop light control remains in its state.
- Control gear is controlled with 90% light output.
- Signals from input devices are ignored.
- Switch actuators are not controlled.

#### App

BlueMode is automatically activated when the following menus are accessed:

- Setup Wizard
- Address
- Create groups
- Configure groups
- Group offset
- Change over groups
- Parameterise devices

As long as BlueMode is activated, the APC's LED indicator flashes blue, with pulses of approximately 1 s. For details see *5.1.5 APC LED indicators*.





BlueMode is automatically ended when the exiting the menu.

## 5.2 App basics

### 5.2.1 Home screen

The home screen appears after starting the app. You can use the <Home> button to get here from other screens.



-  Menu information
-  (above Projects section ) Products section
-  (below Settings menu (here: APC not connected yet)
- 

#### Information

Communication between the app and APC requires a stable Bluetooth connection for the duration of the configuration. Some functions in the Information menu as well as manual downloads and software updates require an internet connection.

## 5.2.2 Menu structure

This is as an overview of the menu structure of the app and makes it easier to quickly access the menu items.

The order corresponds more to the operating logic than to the layout in the app, and some menu items are not shown verbatim.

---

Home screen

### 6 Settings menu

 "No connection"

Bluetooth device overview » Bluetooth connection

 "APC DALI-2"

Device information, location, name

DALI power supply

APC LED indicators

APC software version

User Manual

Change PIN

Device restarts

Reset to factory settings

Disconnect

---

Home screen

### 7 Products section

#### 7.1 Products

Select/Add product

Parameterise » Setup

Information

Documents

#### 7.2 Bluetooth connection

#### 7.3 Setup Wizard

#### 7.4 Setup Wizard

Connect

Address the devices

Create the groups

Assign devices to groups

Set the operating mode of the group(s)

#### 7.5 Manual setup

7.6 Address

7.7 Create groups

## 7.8 Configure groups

### 7.8.1 Operating mode

- Fully automatic
- Semi-automatic
- Manual operation

### 7.8.2 Light

- Automatic light control
- Brightness setpoint
- Light output at start
- Minimum, maximum light output
- Follow-up time
- Manual brightness setpoint adjustment
- Setting brightness measurement

### 7.8.3 Afterglow

- Afterglow
- Light output
- Afterglow duration

### 7.8.4 Orientation light

- Orientation light
- Light output
- Adopt as minimum for automatic light control
- Brightness-dependent
- Brightness switching value

## 7.9 Scenes

- Create scene
- Assign group
- Set light output
- Parameterise push-button
  - Select input device
  - Assign group
  - Assign push-button instance
  - Select input parameters

## 7.10 Group offset

- Select group
- Set offset parameters
- Select main group
- Set subgroup(s)
- Convert groups/subgroups

## 7.11 Change over groups

- Create/select configuration
  - Assign group
  - Select switch input
  - Assign switch instance

7.12 Parameterise devices

- Control gear (lighting)
- Motion sensors
- Light sensors
- Push-button
- Switch
- Actuators

---

Home screen

8 Projects section 

(coming soon)

---

Home screen









9 Menu information 

- Contact form
  - Provisions of use
  - Terms and conditions
  - Options
  - Imprint
- 





















### 5.2.3 Using the app

#### Basic controls and displays

The buttons and displays in the app have the following meaning:

Icon	Comment
Navigating in menus and screens:	
	Open menu information
	Open menu settings
	On the home screen: Open section In the Products menu: Open product
	Open screen section or menu
	At least one requirement to open is missing
	Go to previous screen or menu
	Collapse screen section
	Expand screen section



Icon	Comment
Edit objects (products, groups, etc.):	
	Add an object
	At least one requirement for adding is missing
	Delete an object
	Select to activate
	In device selection: move left/right
	Sort the displayed objects
	Filter in the displayed objects
	Search for objects
Assign participants (devices/instances) to the groups:	
	Operating gear (light) available for identification
	Operating gear (light) switched on during identification
	Detector instance (APC DALI-2 or BMS DALI-2) available for identification
	Detector instance (APC DALI-2 or BMS DALI-2) assigned during identification
	Push-button/switch instance (external) available for identification
	Push-button/switch instance (external) pressed during identification
For parameters, texts, other:	
	Set values
	Enter texts
	Display information on operation
	Display device information
	APC Bluetooth signal strength
	Start download

**Basic options for use**

The app uses many familiar controls and functionalities common to mobile devices.

Special features and tips

- Internet access: Some features as well as downloads and updates require an internet connection. This is indicated in each case.
- Update behaviour: If updates to the app are available, they can be updated automatically or manually depending on mobile device and setting.

- Stand-by behaviour: If the mobile device falls into stand-by and is activated again, the app and APC may have to re-establish the Bluetooth connection.
- Light grey buttons or input fields: The feature is unavailable because a requirement is missing. (Example: A group is missing the participants required for the operating mode).
- Delete product: In the Products section of the <Products> screen, press and hold the relevant entry and swipe left.
- Delete groups: In the Setup Wizard menu in the <Create Groups> screen, press and hold the relevant entry and swipe left.
- The way out for a stuck configuration: Reset the APC to factory settings. For details see *6 Settings menu*.

## 6 Settings menu

### Description

Two options are available when the  button is pressed:



- Screen without Bluetooth connection
- Screen with active Bluetooth connection

- If the app and APC are not yet connected via Bluetooth ("No connection" shown), go to the Bluetooth device overview, select a product and connect via Bluetooth. For details see 7.2 *Bluetooth connection*.
- If the app and APC are already connected via Bluetooth (the device name is shown), go to the <Settings> menu.

### App

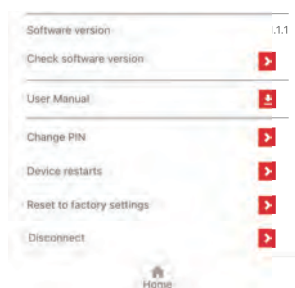

The <Configure>  button takes you to the Setup Wizard screen. For details see 7.3 *Setup Wizard*.

The following information and settings are available in the <Settings> section.

- **Device information, location, name**
  - The APC's GTIN and UID is shown.
  - Entry of floor and room, if desired.
  - Change the device name, if desired.
- **DALI power supply**
  - Switch between internal or external power supply.  
IMPORTANT: This requires special knowledge and measures for the power supply in the DALI-2 bus.
  - Status of the power supply shown.
  - Error check of the power supply shown.
- **APC LED indicators**
  - Activate or deactivate LED feedback on presence detection.
  - Set LED brightness, if desired.
- **APC software version**
  - Software version of the APC shown.
  - Check the software version and update if necessary.  
This requires internet access.  
In addition, you can choose whether or not you want to receive an update notice in the future when establishing a Bluetooth connection.

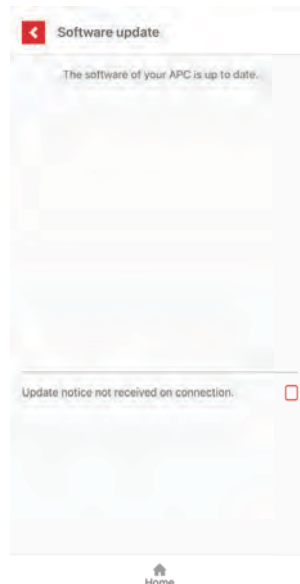

- **User Manual**
  - Download and view the current User Manual.  
This requires internet access.

- **Change PIN**
  - Enter a new PIN code for the APC, if desired.  
Make a note of the new PIN code in your project documents.  
NOTE: The PIN code on the sticker of the APC also works.
- **Device restarts**
  - The APC software is restarted.  
All custom settings are retained.  
The Bluetooth connection must then be re-established. For details see *7.2 Bluetooth connection*.
- **Reset to factory settings**
  - The software of the APC is reset to factory settings.  
ATTENTION: All custom settings (parameters, groups, scenes, etc.) will be deleted.  
The Bluetooth connection must then be re-established. For details see *7.2 Bluetooth connection*.
- **Disconnect**
  - The Bluetooth connection between the app and APC is disconnected.  
The Bluetooth connection must then be re-established. For details see *7.2 Bluetooth connection*.

## 7 Products section

### 7.1 Products

#### Description

The <Products> menu allows you to manage all customisable ESYLUX products and find related information and documents.

#### App

To get to the <Products> menu, tap the <Select products and configure>  button on the home screen. .





– Screen without Bluetooth connection

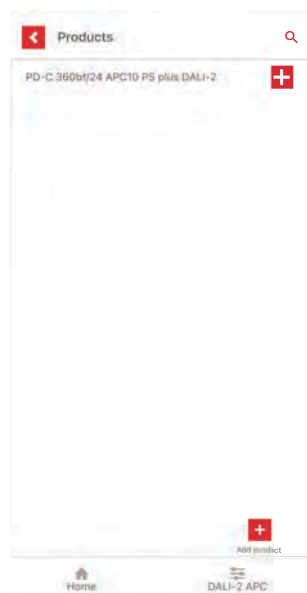

– Screen with active Bluetooth connection

The <Products> menu shows the products already entered in the app.



- You can use the <Add Product>  button to add more products. You can add a new product by barcode (on the product packaging) or search in the manufacturer database. This requires internet access.
- In the list of products, open the product that you currently want to configure.



The following documents are available on this screen:

- Information about the product
- Documents about the product  
This requires internet access.
- The <Configure>  button takes you to the Setup Wizard screen. For details see 7.3 *Setup Wizard*.

## 7.2 Bluetooth connection

### Description

Configuration of the APC requires a Bluetooth connection between the app on your mobile device (smartphone or tablet) and the APC.

### Requirements

- Bluetooth is activated on the mobile device.
- The APC is supplied with mains voltage and is ready for operation.
- The distance between the mobile device and the APC is max. 10 m with no obstructions (door, wall, ceiling).
- If possible, the APC is within line of sight so that you can monitor the LED displays.  
If there are several APCs in an installation, stand directly below the APC concerned if possible.
- For the first connection – during initial commissioning or after reinstalling the app: Have the PIN code of the APC ready. The PIN code can be found on the sticker of the APC.

**IMPORTANT:** Do not leave the Bluetooth range of max. 10 m while the connection is being established. This also applies whenever configuring the APC.

### App

- Tap the  button ("No connection" shown).
- If a location permission notice appears, grant the appropriate permission.
- The <Bluetooth device overview> screen shows the devices within range via Bluetooth.



- Tap the line [APC]. If several APCs are displayed in an installation, select the line [APC] with the highest signal strength.
- When the <Bluetooth pairing request> window appears, enter the PIN code of the APC.



- The LED on the APC flashes with short blue pulses.
- Wait until all instructions have run their course.

When the connection is established, you are taken to the Setup Wizard screen. For details see *7.3 Setup Wizard*.

## 7.3 Setup Wizard

### Description

Two functions are available for setting up the APC:

- Setup Wizard
- Manual setup

### App

You can access the Setup Wizard screen automatically during initial commissioning – or following a factory reset – as well as via the <Products> menu.

The Setup Wizard screen is the main place to set up the APC.

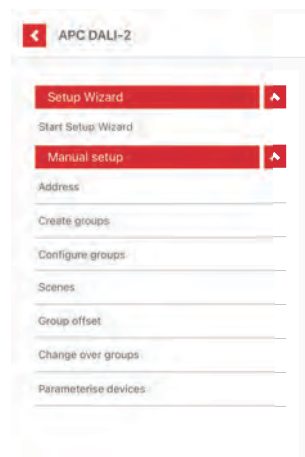

## 7.4 Setup Wizard

### Description

The <Setup Wizard> function is a handy tool. It can be used to safely carry out the first configuration during initial commissioning - or following a factory reset.

- If the APC has already been set up, the Setup Wizard will cancel in order to avoid unintentionally overwriting the existing configuration.
- If you want to completely reconfigure the APC in any case, first perform a factory reset in the <Settings> menu.

### App

The <Setup Wizard> function can be found at the top of the Setup Wizard screen.



The Setup Wizard goes through the following steps:

1. Connect
2. Address the devices
3. Create the groups
4. Assign participants to groups
5. Set the operating mode of the group(s)

#### 1. Connect

After starting the Setup Wizard, the app and APC first connect via Bluetooth.

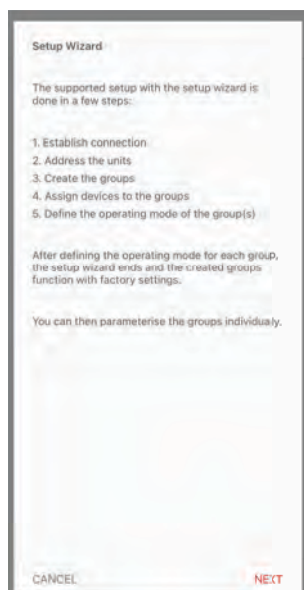

## 2. Address the devices

In this step, the DALI-2 bus is queried and the connected bus participants (devices) are addressed.



The participants identified on the DALI-2 bus and provided with an address are listed by category:

- APC DALI-2
- Control gear
- Input devices
- Actuators

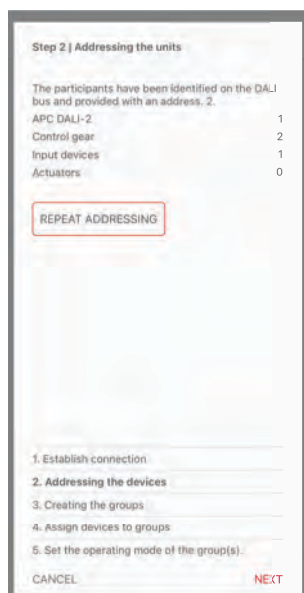

- Addressing can be repeated if necessary.

### 3. Create the groups

Create groups for participants to act in the same way within the group.



- Use the **+** button to create additional groups.
- Enter a meaningful name for the group name to make it easier to tell them apart later on.  
A maximum of 16 characters can be used for a group name.

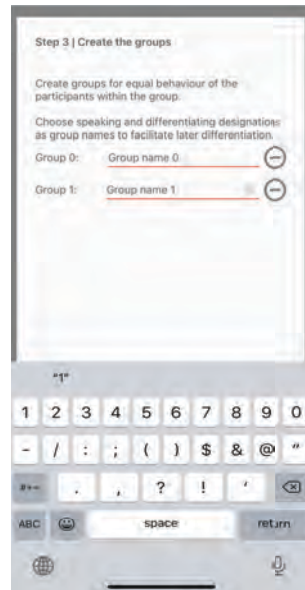

#### 4. Assign participants to group(s)



Assign at least one group to each participant.



– Select participant, here: Control gear



– Assign group, here: Group 2

- Use the   buttons to select the device type and the respective participant – recognisable by the flashing icon.
- From the groups offered, select at least one group to which the participant is to be assigned.

- Enter a meaningful name for the device and enter the installation location of the device (floor and room). Numerical values from -9 to 200 can be entered for floor and room.

**5. Set the operating mode of the group(s)**

Select an operating mode for each group created:

- Fully automatic (default setting)
- Semi-automatic
- Manual operation

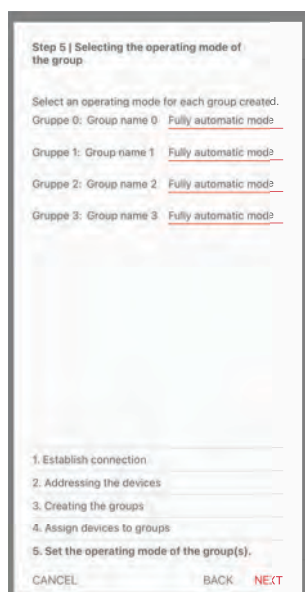

For details see *7.8.1 Operating mode*.

After setting the operating mode for each group, the Setup Wizard ends.

NOTE: With the Setup Wizard, all devices together with their instances (e.g. a presence detector with its motion and light sensors) are addressed and assigned to groups. This allows quick, basic configuration. Subsequently, individual instances can be configured specifically.

- Changes and additions to the configuration are made with the <Manual setup> function. For details see *7.5 Manual setup*.

**7.5 Manual setup**

**Description**

The <Manual setup> function is a flexible tool. With this tool – in addition to the Setup Wizard – special functions can be selected, activated or deactivated and settings can be made.

## App

The <Manual setup> function can be found in the Setup screen below the Setup Wizard.

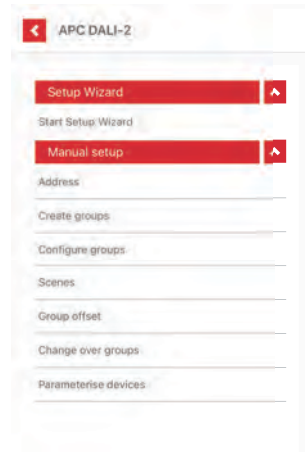

The following options are available with this function:

- Address
- Create groups
- Configure groups
- Scenes
- Group offset
- Change over groups
- Parameterise devices

## 7.6 Address

### Description

Addressing all of the bus participants is a requirement for a complete and successful configuration.

When addressing, each bus participant (device/instance) receives a unique identifier in the DALI-2 bus.

### App

Two ways are available for addressing:

- Via the <Setup Wizard> function, e.g. after the initial commissioning or after a factory reset. For details see *7.4 Setup Wizard*.
- Via the <Manual setup> function, e.g. after connecting new bus devices or if the entire Setup Wizard does not need to be run through.



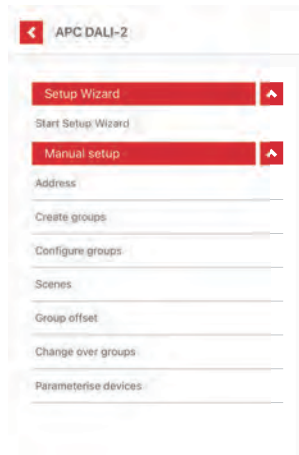

After accessing addressing, the currently addressed devices are listed:

- APC DALI-2
- Control gear
- Input devices
- Actuators



There are two options for addressing manually:

- New installation  
All participants receive a new DALI-2 address. All previous addresses are deleted.
- Post-installation  
Only newly added or previously unrecognised participants receive a new DALI-2 address. All other participants retain their address.

The address range can be defined for this purpose:

- Entire DALI-2 bus
- All control gear
- All input devices

Once addressing is finished, all addressed devices can be configured.

- Check whether all installed devices have been found in the DALI-2 bus.
- If any devices are missing, check the electrical installation and carry out a subsequent installation.

## 7.7 Create groups

### Description

The individual grouping of lights in a room zone permits group operation. For details see *5.1.2 Group operation*.

If no groups are created, the system is in broadcast mode. For details see *5.1.1 Broadcast mode*.

### App

There are two ways to create groups:

- Via the <Setup Wizard> function, e.g. after the initial commissioning or after a factory reset. For details see *7.4 Setup Wizard*.
- Via the <Manual setup> function, e.g. after connecting new bus devices or if the entire Setup Wizard does not need to be run through.

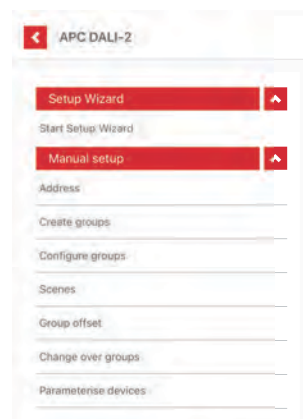

After accessing the <Create groups> menu, the following options are available:



- Use the **+** button to create a new group.  
For details see 3. *Create the groups.*
- With the function <Assign participants to groups> **+** you then assign each participant at least one group.  
For details see 4. *Assign participants to group(s).*



- By swiping left, you can use the **🗑️** button to delete a group.

## 7.8 Configure groups

### Description

All group-related settings can be made with the <Configure groups> function.

### App

You get to the <Configure groups> menu from the <Manual setup> menu.

When accessing the menu, the following situations may occur:



– If no group is set up

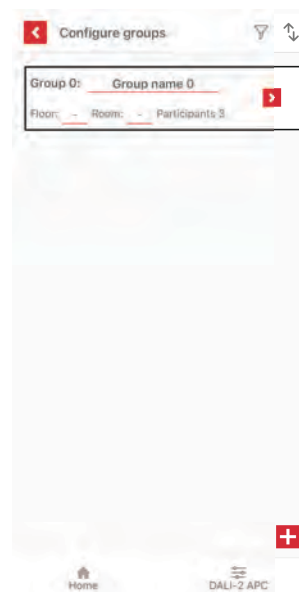

– If one group has already been set up

- If no group is set up: Use the **+** button to create at least one group. Enter a meaningful name for the group name to make it easier to tell them apart later on.  
A maximum of 16 characters can be used for a group name.
- If a group is already set up: tap the **+** button and configure the group.

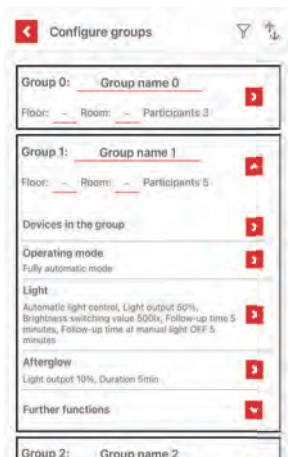

The following options are available for each of the groups:

- Parameterise group devices  
For details see *7.12 Parameterise devices*.
- Select operating mode
- Parameterise light
- Afterglow
- Orientation light

NOTE: Depending on the operating mode of a group, certain devices/ instances must be present and parameterised in this group. For details see *5.1.4 Minimum constellations*.

- If more groups are desired: Use the **+** button to create additional groups.

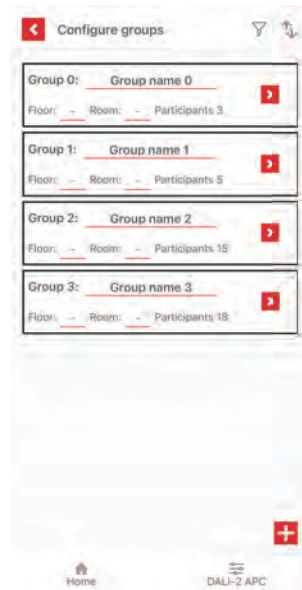

### 7.8.1 Operating mode

#### Description

- The operating mode is used to determine whether lighting control is to be fully automatic, started manually or manually alone.
- In broadcast mode, the operating mode applies to all bus participants.
- In group operation, an operating mode only applies to one group. This means that each group can have its own operating mode.

#### Requirements

- Depending on the operating mode of a group, certain devices/ instances must be present and parameterised in this group. For details see *5.1.4 Minimum constellations*.

## App

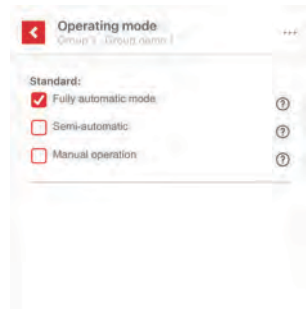

### Adjustable modes

Operating mode	Comment
Fully automatic	Automatic light control/light control is automatically started by presence detection.
Semi-automatic	Lighting is switched on at the touch of a button and switches off automatically.
Manual operation	Lighting is switched on and off again at the touch of a button.

IMPORTANT: Specific parameters apply to each operating mode. For this reason, check each time you change the operating mode whether the parameters set meet your requirements.

### Fully automatic

- Devices/instances required in the group:
  - Presence detector
  - Light sensor
- Automatic light control/light control is automatically started by presence detection.
- As long as presence is detected, this state remains. Afterwards, follow-up time begins.
- Each presence detection restarts follow-up time.
- Important parameters:

Parameter	Unit	Comment
Brightness setpoint	lx (Lux)	for automatic light control
Brightness switching value	lx (Lux)	for closed-loop light control
Light output	%	
Follow-up time	hh:mm	

For details on automatic light control/light control, see *7.8.2 Light*.

**Semi-automatic**

- Devices/instances required in the group:
  - Presence detector
  - Light sensor
  - Push-button
- The lighting is switched on by pressing a button.
- Pressing the button has the following effect depending on current brightness:
  - measured brightness < brightness setpoint: Automatic light control starts. For details see *Automatic light control*.
  - measured brightness > brightness setpoint: Manual override starts. For details see *Manual brightness setpoint adjustment*.
- NOTE: Rapid changes in brightness may produce different results.
- As long as presence is detected, this state remains. Afterwards, follow-up time begins.
- Each presence detection or a new key press restarts follow-up time.
- Important parameters:

Parameter	Unit	Comment
Brightness setpoint	lx (Lux)	for automatic light control
Brightness switching value	lx (Lux)	for closed-loop light control
Light output	%	
Follow-up time	hh:mm	

**Manual operation**

- Devices/instances required in the group:
  - Push-button
- Lighting is switched on and off again at the touch of a button.
- The lighting remains in the selected state until the button is pressed again.
- Important parameters:

Parameter	Unit	Comment
Light output	%	closed-loop light control only



## 7.8.2 Light

### Description

In the <Light> menu, all group-related settings for light values and light outputs can be made:

- Automatic light control
- Brightness setpoint/brightness switching value
- Light output at start
- Minimum light output, maximum light output
- Follow-up time
- Manual brightness setpoint adjustment

as well as

- Setting brightness measurement

### App

You get to the <Light> menu from the <Configure Groups> menu.

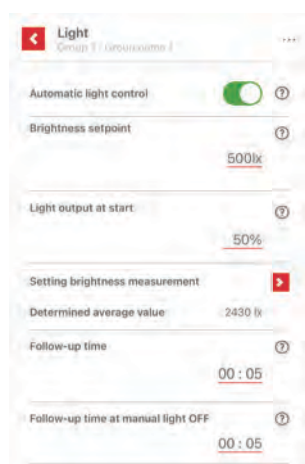

### Automatic light control

Automatic light control can be activated or deactivated. With automatic light control deactivated, light control takes place.

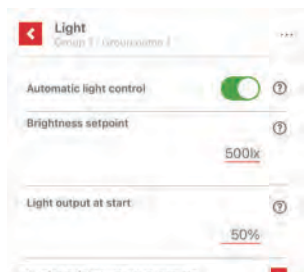

- Automatic light control activated
- Automatic light control deactivated
- Automatic light control activated:  
Lighting is controlled to a constant brightness level – depending on the amount of daylight.
- Automatic light control deactivated ("Light control"):  
Lighting is switched with a predefined, adjustable light output. For details see *5.1.3 Open-loop light control - Closed-loop light control*.

Adjustable parameters for automatic light control:

Parameter	Setting values	Default value
Brightness setpoint	100-2000 lx (in 10-lx steps)	500 lx
Light output at start	0-100 % (in 10% steps)	50 %
Follow-up time	00:01 - 24:00	00:05
Follow-up time at manual light OFF	00:01 - 24:00	00:05
Minimum light output	0-100 %	0 %
Maximum light output	0-100 %	100 %
Manual brightness setpoint adjustment via push-button	None, Temporary, Permanent	None

Adjustable parameters for light control:

Parameter	Setting values	Default value
Brightness switching value	10-2000 lx (in 10-lx steps)	500 lx
Light output	0-100 %	50 %
Follow-up time	00:01 - 24:00	00:05
Follow-up time at manual light OFF	00:01 - 24:00	00:05

### Brightness setpoint

The brightness setpoint is the target value of automatic light control.

Brightness is continuously measured via light sensors and compared with the brightness setpoint. Light output is constantly adjusted so that the difference between the measured brightness and the brightness setpoint is minimised.

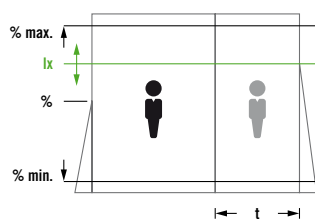

If required, the brightness measurement can be adapted to individual conditions. For details see *Setting brightness measurement*.

**Light output at start**

Initial value of light output at the beginning of automatic light control/ light control. The system regulates up or down from this value after the light measurement has been completed.

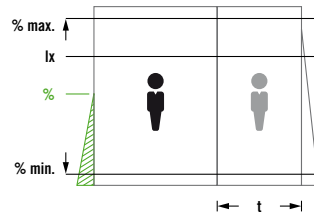

NOTE: The behaviour when [Light output at start] is set equal to [0 %] depends on several factors.

Automatic light control	Room brightness	Effect
activated	bright – above the brightness setpoint	No light output.
activated	dark – below the brightness setpoint	Light output does not start at 0%, but at an adaptively determined value.
deactivated	bright - above the brightness switching value	No light output. When the room becomes darker and presence is detected, the lighting is switched on.
deactivated	dark - below the brightness switching value	No light output.

**Minimum light output, maximum light output**

With <Minimum light output>, light output in automatic light control is limited downwards. Automatic light control will not fall below this minimum light output.

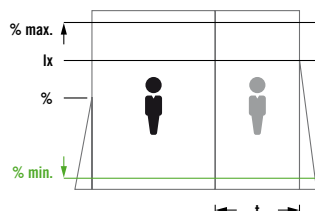

With <Maximum light output>, light output in automatic light control is limited upwards. Automatic light control will not exceed this maximum light output.

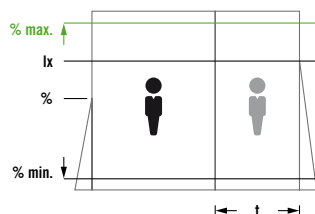

NOTE: Due to the limitation of light output, the actual brightness value in the room may fall below the legally prescribed values. If in doubt, verify compliance with these values by measuring the brightness.

**Follow-up time**

Time after the last presence detection in which the light still remains ON.

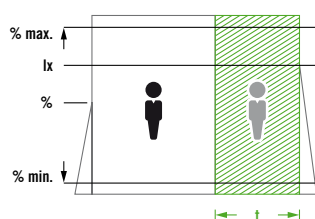

Subsequently, an afterglow can be defined.

**Follow-up time at manual light OFF**

A separate follow-up time can be set for manual override <Light OFF>, e.g. for a presentation.

Each detected motion restarts the follow-up time.

### Manual brightness setpoint adjustment

If the light is dimmed up or down manually during automatic light control, the new brightness value can be recorded in the room as a new brightness setpoint.

Prerequisite: A push-button for dimming UP/DOWN has been defined.

With the [Temporary] setting, the new brightness setpoint is in effect until the end of current automatic light control. With a new presence detection, automatic light control starts again with the old brightness setpoint.

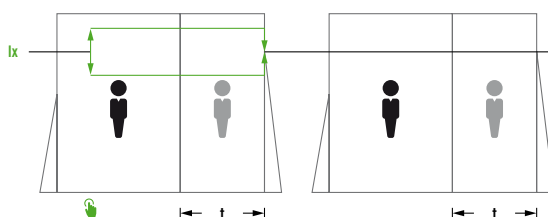

If set to [Permanent], the new brightness setpoint is in effect for all future automatic light controls.

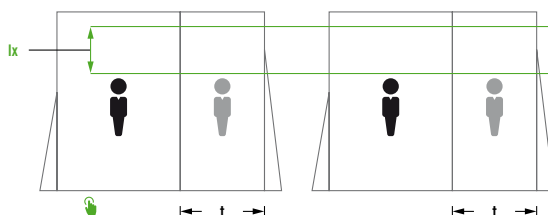

### Setting brightness measurement

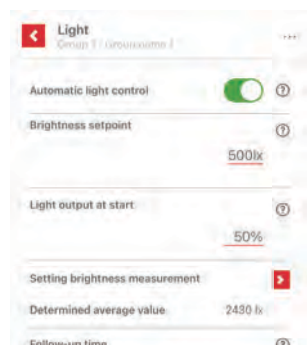

This allows you to determine the optimal lighting at the intended workplace and ensure efficient light control.

Requirements:

- For the measurements you need a suitable illuminance measuring device ("luxmeter").
- The room must be completely darkened to obtain error-free measurements and optimal results.

Behaviour of the control system:

- In order to be able to optimally set the parameters for brightness measurement, the entire control system is stopped.
- The lights of the group to be set are switched to 100%. The remaining lights are switched to the minimum light value.
- As long as the brightness measurement is active, the control system will not react to presence detection or manual push-button/switch commands.

Step 1: <Setting light sensors>

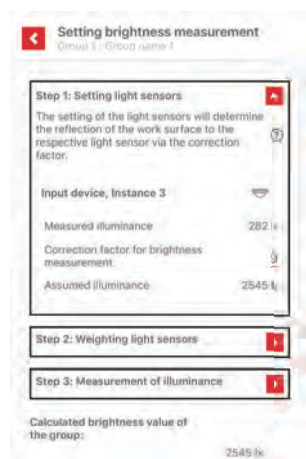

With a correction factor for each light sensor, the measured value of the light sensor can be corrected to take into account the actual light reflections where the sensor is mounted.

- Measure the illuminance below the light sensor.

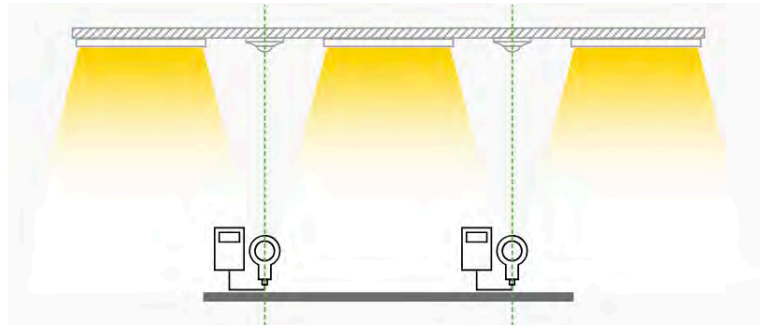

- Enter the measured value at the [Correction factor] parameter. This can be used to change the value for the assumed illuminance:  $\text{Measured value} \times \text{correction factor} = \text{assumed illuminance}$ . This value should be as close as possible to the measured illuminance.

#### Step 2: <Weighting light sensors>

The light sensors of the group can be freely weighted to prioritise the brightness values at different measuring points.

- It is recommended to weight measuring points in darker areas higher than light sensors in areas with more natural light.

NOTE: A maximum of four light sensors can be assigned to each group, i.e. two external light sensors in addition to the two APC light sensors.

#### Step 3: <Measurement of illuminance>

Light control can be adjusted to the expected amount of daylight in the room.

- Measure the illuminance at the intended workstation (e.g. at the height of the desk surface).

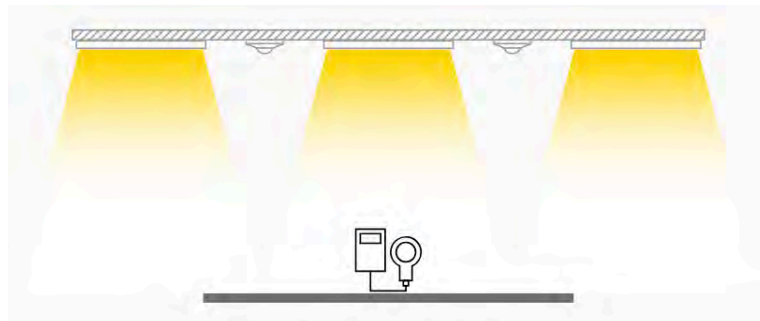

- Enter the measured value for the parameter [Illuminance of the group].



- Use the slider to set the expected amount of daylight in the room (see table).  
The higher the amount of daylight, the more the measured brightness value is corrected downwards to always ensure optimal light control.

Expected daylight	Position of the slider
little to no daylight (e.g. north side, no or very small windows)	towards the moon icon
little to medium amount of daylight (e.g. east or west side, normal window areas)	between moon and sun icon
a lot of daylight (e.g. south side, many windows or large window fronts)	towards the sun icon

### 7.8.3 Afterglow

#### Description

- Afterglow is an additional function for automatic light control or light control.
- Afterglow starts after the follow-up time of an automatic light control or light control has elapsed and prevents unwanted darkness.
- During the afterglow duration, light output is controlled to a value relative to the standard light level. After the afterglow duration has expired, a separate afterglow time runs.

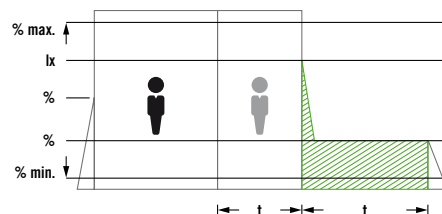

- If automatic light control would control below the light level in afterglow, afterglow is not used.
- In case of presence detection during afterglow, the previously used function is reactivated.
- A light scene can be accessed during afterglow.

#### Requirements

- Afterglow must be activated. Afterglow is deactivated in the factory setting.
- The control system is in [Fully automatic] or [Semi-automatic] operating mode.
- Light output in the previous state is greater than/equal to the light output when afterglow started.

### App

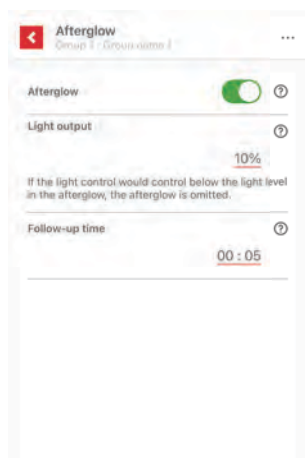

### Adjustable parameters

Parameter	Setting values	Default value
Activate/deactivate afterglow	ON, OFF	OFF
Light output	10-100 % (in 10% steps)	10 %
Follow-up time (afterglow duration)	00:01 - 24:00	00:05

- The light output of afterglow is usually below the standard light output.

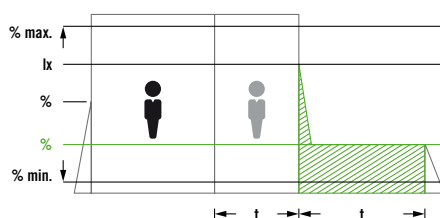

- Afterglow duration determines how long – after the follow-up time – afterglow is activated.

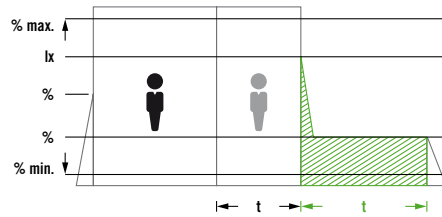

### 7.8.4 Orientation light

#### Description

- Orientation light is an additional function for automatic light control, light control and manual override (e.g. by push-button).
- Orientation light provides the minimum lighting of a room, even if there is no presence detection.
- Orientation light can be switched off completely, switched on permanently or switched on as needed when there is not much light (setting [Brightness-dependent]).

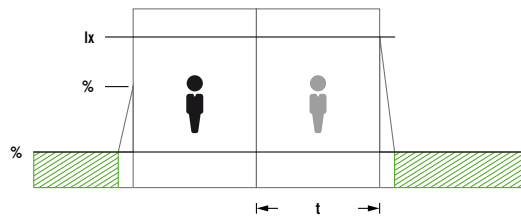

- Depending on operating mode, orientation light is exited when special events (presence detection, button press, etc.) occur.
- In the [Brightness-dependent] setting, orientation light is exited when the brightness threshold is exceeded.
- During orientation light, a light scene can be accessed.

#### Requirements

- Orientation light must be activated. Orientation light is deactivated in the factory setting.
- The control system is in [Fully automatic], [Semi-automatic] or [Manual operation] mode.

App

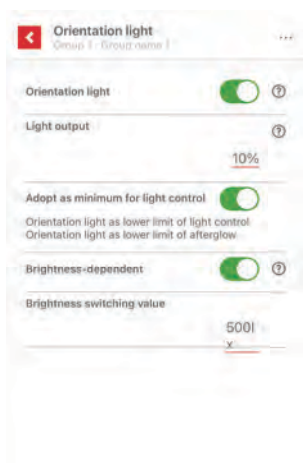

Adjustable parameters

Parameter	Setting values	Default value
Activate/deactivate orientation light	ON, OFF	OFF
Light output	5-50 % (in 5% steps)	10 %
Adopt as minimum for automatic light control	ON, OFF	OFF
Brightness-dependent	ON, OFF	OFF
Brightness switching value (brightness-dependent)	100-2000 lx	100 lx

- Light output: Light output defined for orientation light, based on standard light output.



- Adopt as minimum for automatic light control: Activates or deactivates the use of the light output of orientation light as the lower limit of light control and afterglow (if afterglow is activated).
- Brightness-dependent: Activates or deactivates brightness-dependent switching of orientation light.
- Brightness switching value: Brightness threshold at which the orientation light is switched on or off (if brightness-dependent is activated).

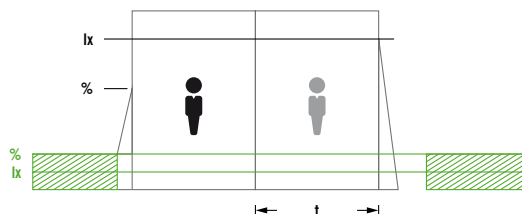

## 7.9 Scenes

### Description

- A scene is activated via a push-button and accesses a predefined illumination level or switch actuator function.
- When light output is accessed: The operating devices of the group are controlled with constant, adjustable light output.
- A scene can be used for several groups. Each group can be given individual parameters.
- No other functions are possible during the scene – except for manual override.
- A scene is ended by manual override or the [Automatic mode] button function.



### Requirements

- The button instance that accesses the scene must be assigned to the relevant groups of this scene in order to start the scene in these groups. For details see *7.12.4 Push-button*.
- To use the switching actuator: A switching actuator with the relay function [Switch HVAC] must be assigned to the group.

## App

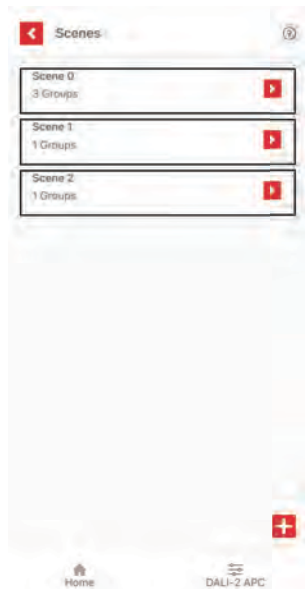
You can get to the <Scenes> function from the <Products> menu.



- Use the  button to create a new scene.
- Use the  button to access a scene in order to edit it.



### Settings to be made

Parameterise push-button:

To be able to start a scene, the function [Start scene] must be selected on the desired push-button for the brief push-button action and the appropriate scene number must be set.



- Press the desired button to identify the appropriate instance. To identify the push-button instance the icon flashes 🖱️🖱️🖱️🖱️.
- You can use the ⓘ icon to access further information.

Assign group:

A scene can be used for several groups. The groups relevant for the scene can be selected under [Assign group].

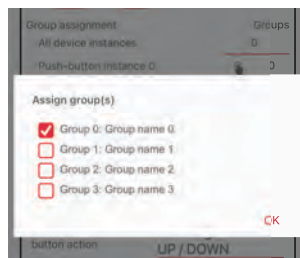

**Adjustable parameters**

Parameter	Setting values	Default value
Light output	0-100 %	100 %
Actuator	ON, OFF	ON

**7.10 Group offset**

**Description**

- For automated lighting control, one presence detector with light sensor is usually installed per area.
- For optimal energy efficiency, it may be necessary, even with only one measuring point (light sensor), to step down the illuminance of individual light groups by means of offsets.
- Lights near and far from windows are divided into groups and a control offset between the groups is set up using the <Group offset> function.

- The main group determines light control. The subgroups follow the main group and adopt the parameters of the main group.
- In daylight, the light output of the lights near the window is reduced more than the light output of the lights far from the window.

### Requirements

- The main group has a light sensor instance.
- At least one other group is configured as a subgroup.

### App

You can get to the <Group offset> function from the <Products> menu.

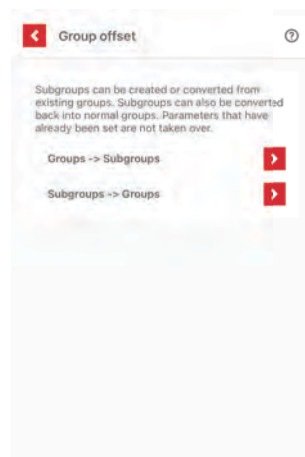

The following options are available here:

- Groups » Subgroups:  
Existing groups can be converted into subgroups. Subgroups lose their set parameters and adopt the parameters of the main group.
- Subgroups » Groups:  
Subgroups can be converted back into normal groups. Parameters that have already been set are not adopted.



NOTE: The sum of all main groups and subgroups can be a maximum of 16.

IMPORTANT: A group with a light sensor instance must be selected as the main group.

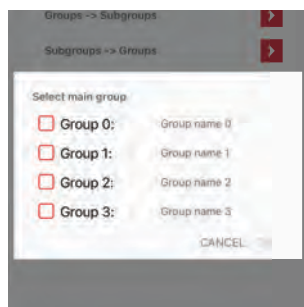

The offset parameters must be set for these groups.

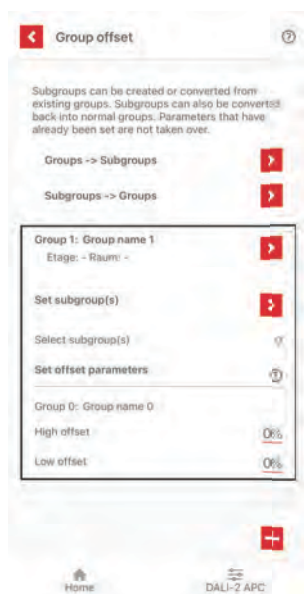

### Adjustable parameters

Parameter	for main group light output	Setting values	Default value
Upper offset	75 %	-50-+20 %	0 %
Lower offset	25 %	-20-+50 %	0 %

With the default values (upper offset 0%, lower offset 0%), the light outputs of the main group and subgroups are identical.

Resulting light control depending on the incidence of daylight:

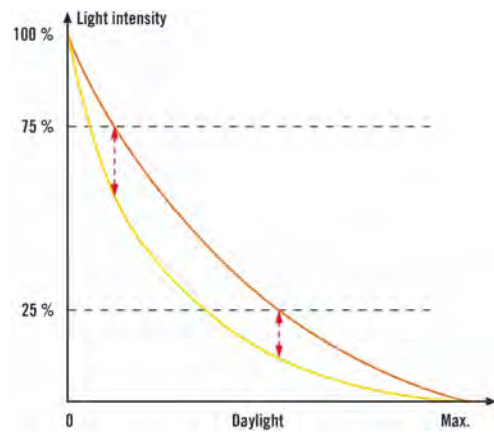

- Light output of main group (lights far from window)
- Light output subgroups (lights near window), example:
  - upper offset 20%
  - lower offset 10%

**Application example: Group offset near the window**

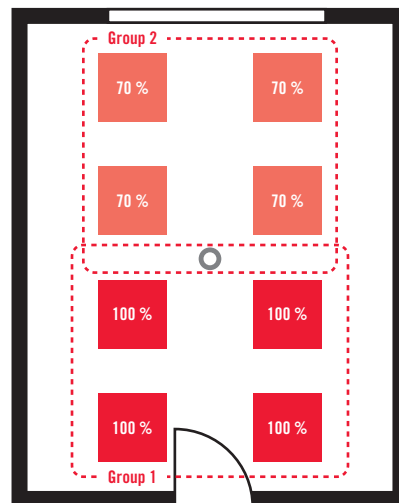

- Light (light output in %)
- Presence detector (e.g. an APC DALI-2)

Explanation: Due to the offset between the groups, light output of the lights near the window is reduced more than the light output of the lights far from the window in daylight.

NOTE: The <Group offset> function can be combined with the <Change over groups> function. For details see 7.11 *Change over groups*.

## 7.11 Change over groups

### Description

- With the <Change over groups> function, areas can be used in flexibly combinable groups. The lights of an area are assigned to several groups at the same time.
- This allows changing the use of certain areas, depending on the specific application situation.
- An external light switch or the contact switch of a partition wall triggers the group switch. For details see *7.12.5 Switch*.

### Requirements

- An external light switch or the contact switch of a partition wall is connected to one of the push-button inputs S1-S4.
- The button instance for this button input is deactivated, i.e. **all three** button functions ([Short button press], [Long button press] and [Double button press]) are set to [No function]. For details see *7.12.4 Push-button*.
- The switch instance for this button input is set to [Change over groups ON] or [Change over groups OFF].

### App

You can get to the <Change over groups> function from the <Products> menu.



Create group switch:

- Use the  button to add a new configuration.

Edit group switch:

- Use the  button to access a configuration for editing.

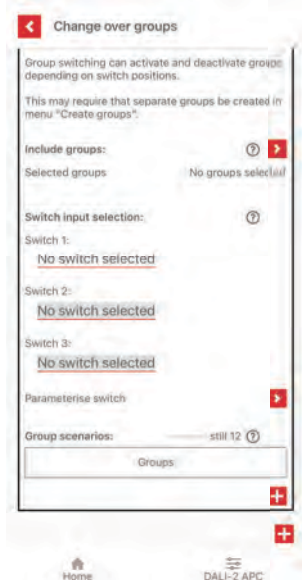

Include groups:

This is used to assign all groups that can be activated or deactivated in this configuration.

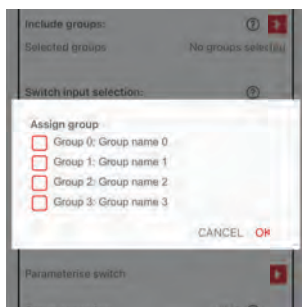

If necessary, additional merged groups must be created beforehand.

Switch selection:

This selects the switches to be used to activate or deactivate groups in this configuration. A maximum of three switches can be used in one configuration.

To activate and deactivate, the switch function must be changed in the settings of the switches.

Parameterise switch:

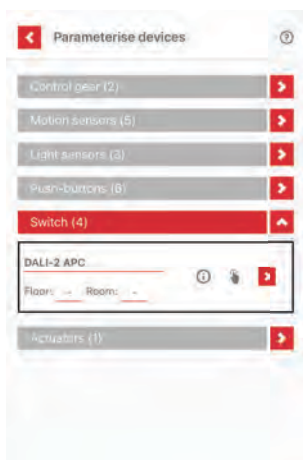

The button inputs are assigned to the following instances of the APC:

Button input	Button instance*	Switch instance
S1	0	4
S2	1	5
S3	2	6
S4	3	7

\* The button instance used must be deactivated.

Group scenarios:

The possible number of group scenarios depends on the number of assigned switch instances.

Number of switch instances	Number of switch positions	Number of group scenarios
1	2 (1 open + 1 closed)	2
2	2 x 2	4
3	2 x 2 x 2	8

NOTE: When a switch instance is removed from the switch selection, the associated group scenarios are removed.

**Application example: Group switching**

Situation 1: Conference room with closed partition wall

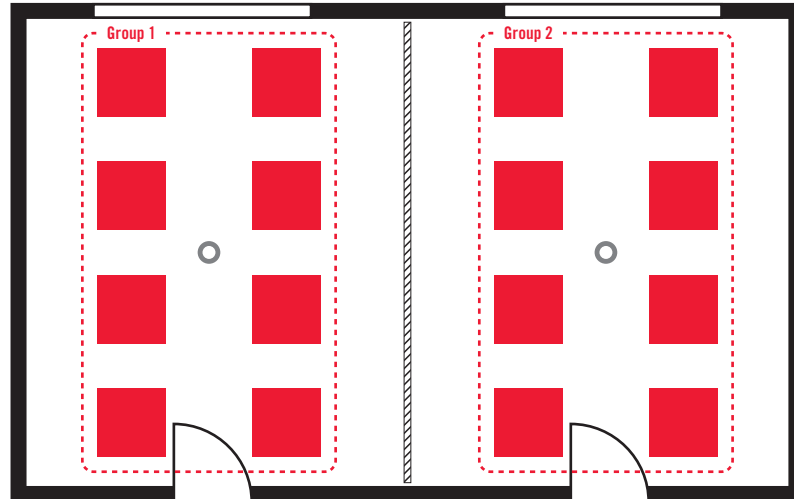

- Light
- Presence detector (e.g. an APC DALI-2, a BMS DALI-2)

Explanation: A closed partition divides a room into two halves. The lights and presence detectors in the two halves of the room are assigned to group 1 or group 2 accordingly. In each group there is individual light control.

Situation 2: Conference room with open partition wall

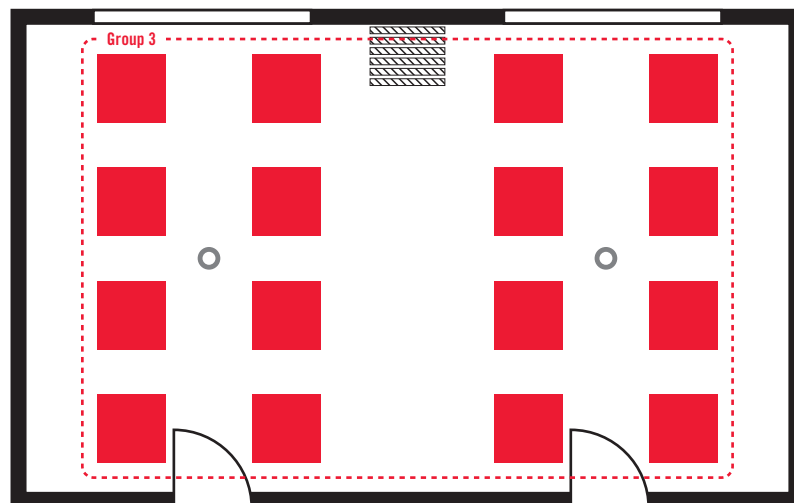

- Light
- Presence detector (e.g. an APC DALI-2, a BMS DALI-2)

Explanation: All lights and presence detectors of the room are additionally assigned to a group 3. When the partition wall is opened, groups 1 and 2 are deactivated and group 3 is activated at the same time via the push-button input of the presence detector (external push-button). Uniform light control takes place in the entire room.

NOTE: The <Change over groups> function can be combined with the <Group offset> function. For details see 7.10 *Group offset*.

**Application example: Group switching with group offset**

Situation 1: Classroom during teaching

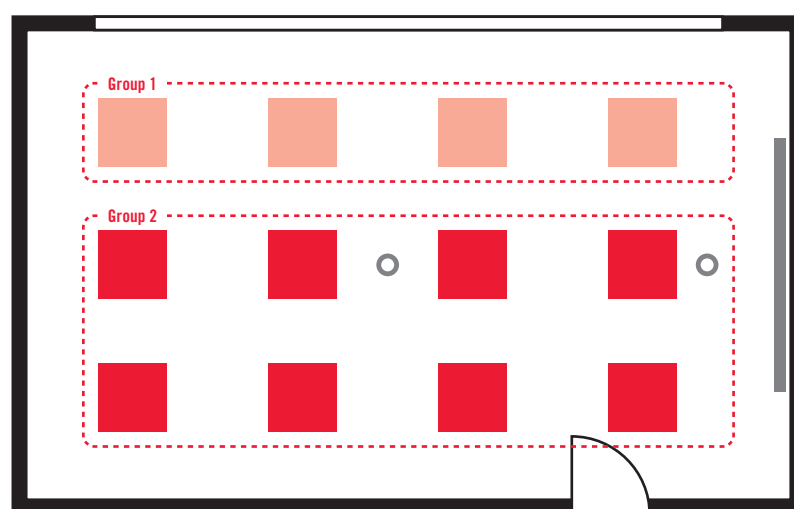

Explanation: In a classroom, groups 1 and 2 are active during normal teaching. A group offset is set between the two groups because the lights near the windows require less illuminance.

## Situation 2: Classroom during a presentation

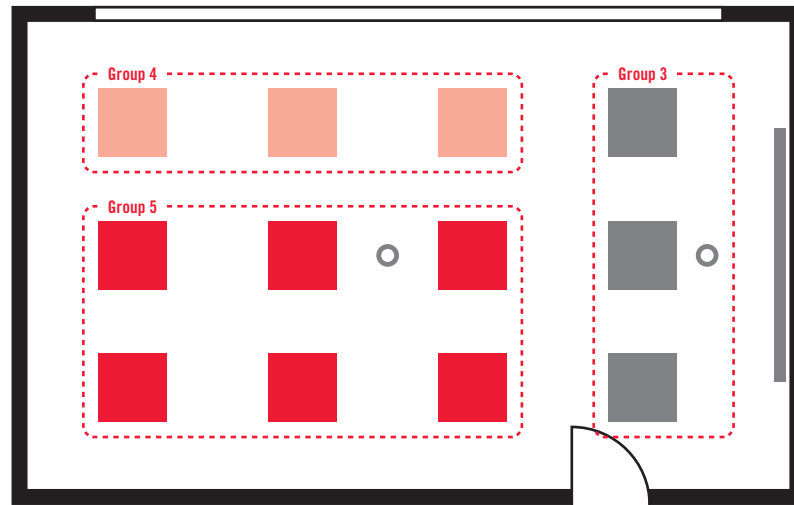

- Light (high illuminance)
- Light (dimmed illuminance)
- Light (dimmed to 0%)
- Presence detector (e.g. a APC DALI-2 on the left, a BMS DALI-2 on the right)

Explanation: When the light switch (external button) is pressed at the beginning of a presentation, groups 1 and 2 are deactivated and groups 3, 4 and 5 are activated at the same time. The illuminance of group 3 in the presentation area is dimmed to 0%. Groups 4 and 5 continue to work with group offset, but with a lower setpoint and thus with dimmed illuminance for the presentation.



## 7.12 Parameterise devices

### Description

- In the <Parameterise devices> menu, devices/instances can be parameterised and assigned to the previously set up groups.
- Instances are partial components of a device that fulfil an independent function, e.g. presence detection, brightness measurement or push-button input.
- Instances do not have their own DALI-2 address, but use the address of the respective device.
- Instances are handled separately and can be assigned to different groups and functions.

### App

From the <Parameterise devices> menu, you can edit the following devices/instances:

- Control gear
- Motion sensors
- Light sensors
- Push-button
- Switch
- Actuators



The number of devices/instances currently addressed in the DALI-2 bus is shown in brackets.

### 7.12.1 Control gear (lighting)

#### Description

- Control gear is the DALI designation for a light fitting, in particular for the electronic control gear (ECG) that acts as a bus device.
- A control gear is addressed in the DALI-2 bus as a device as a whole. There are no instances such as a light sensor in an APC.

#### App

You can get to the <Control gear> screen from the <Parameterise devices> menu.

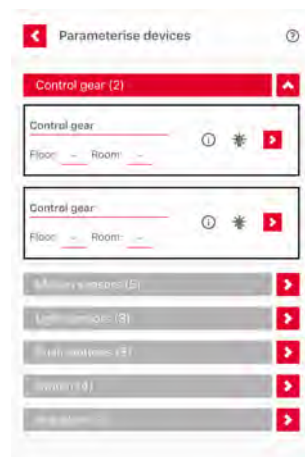

- When a control gear is identified, the icon flashes \* \* \* \* .
- You can use the ⓘ icon to access the device information of the ECG for each control gear:
  - Short address
  - Manufacturer
  - GTIN
  - UID
- The ▶ and ▲ buttons can be used to access or hide other settings.

### 7.12.2 Motion sensors

#### Description

- The motion sensors in the APC detect the presence and movement of people in the room. They perform presence detection.
- The included 180° lens mask is used to limit the detection range. For details see *4 Installation*.
- The response behaviour, i.e. the sensitivity of the motion sensors, can be individually adjusted.

- Each time a presence is detected, the APC provides feedback via the built-in LED display. The brightness of the LED display can be adjusted.
- LED feedback can also be deactivated. For details see *6 Settings menu*.
- The motion sensors are assigned to the following presence detector instances of the APC:





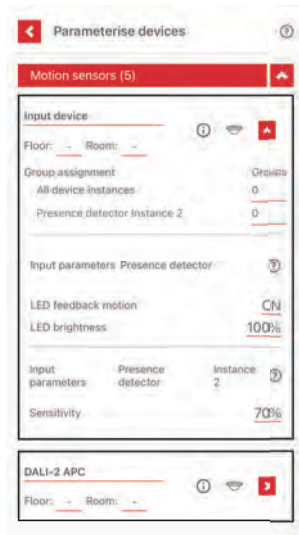

Motion sensor	Presence detector instance for PD-C 360bt/8 APC...	Presence detector instance for PD-C 360bt/24 APC... PD-C 360bt/32 APC...
1.	8	8
2.	–	9
3.	–	10
4.	–	11

The assignment of instances may differ for other input devices (e.g. BMS detectors). For more details, please refer to the appropriate user manual.

### App

You can get to the <Motion sensors> screen from the <Parameterise devices> menu.



- The icon flashes when a presence detector instance is identified    .
- You can use the  icon to access further information.
- The  and  buttons can be used to access or hide other settings.

### Adjustable parameters

The following settings can be made for each presence detector instance:

Parameter	Comment	Setting values	Default value
Movement LED response	This allows you to set the extent to which presence detection triggers an LED response from the APC.	ON, OFF	ON
LED brightness	This allows you to set the brightness the LED uses in responses.	10-100% (in 10% steps)	50%
Sensitivity	If external disturbances (radiators, air conditioning, etc.) produce faulty switching, the sensitivity of the sensors should be reduced.	10-100% (in 10% steps)	100%

### 7.12.3 Light sensors

#### Description

- The light sensors in the APC detect direct incident light and light reflected from the room at the installation site.
- The actual illuminance measured at the installation site can deviate from the assumed target illuminance at the intended workplace.
- To compensate for this, the measured value of the light sensors can be adjusted with the help of a correction factor.
- If a suitable illuminance measuring device ("luxmeter") is available, you can also carry out an exact brightness measurement at the workplace. For details see *Setting brightness measurement*.
- The light sensors are assigned to the following light sensor instances of the APC:

Light sensor	Light sensor instance with PD-C 360bt/8 APC...	Light sensor instance with PD-C 360bt/24 APC... PD-C 360bt/32 APC...
1.	9	12
2.	10	13





The assignment of instances may differ for other input devices (e.g. BMS detectors). For more details, please refer to the appropriate user manual.

NOTE: A maximum of four light sensors can be assigned to each group, i.e. two external light sensors in addition to the two APC light sensors.

### App

You can get to the <Light sensors> screen from the <Parameterise devices> menu.



- When identifying a light sensor instance, the icon flashes .
- You can use the  icon to access further information.
- The  and  buttons can be used to access or hide other settings.

### Adjustable parameters

The following settings can be made for each light sensor instance:

Parameter	Default value for PD-C 360bt/8 APC...	Default value for PD-C 360bt/24 APC... PD-C 360bt/32 APC...	Setting value	Comment
Correction factor for brightness measurement	9.5	7.5	same as default value	The light sensor correctly reports the actual illuminance.
			less than default value	It is too bright at the light sensor. The measured value is corrected downwards.
			greater than default value	It is too dark at the light sensor. The measured value is corrected upwards.

### 7.12.4 Push-button

#### Description

- External push-buttons can be used, for example, to switch lights on or off, dim lights and access scenes.
- A push-button in the logical sense is any electrical push-button contact of a push-button switch insert.

- Up to four push-buttons can be connected to push-button inputs S1-S4 of the APC with one pole.
- The number of push-button switch inserts that can be used per APC depends on the design of each insert:

Push-button switch insert	Contacts	Usable per APC
Single push-button	1 NO contact	4 pieces
Double push-button	2 NO contacts	2 pieces
Double rocker push-button	4 NO contacts	1 piece

- The button inputs are assigned to the following button instances of the APC:





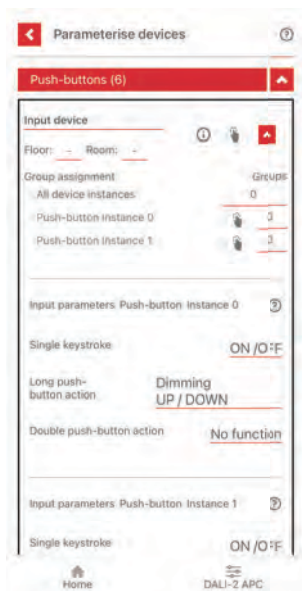

Button input	Button instance
S1	0
S2	1
S3	2
S4	3

The assignment of the button inputs to the button instances may differ for other input devices (e.g. BMS detectors). For more details, please refer to the appropriate user manual.

### App

You can get to the <Button> screen from the <Parameterise devices> menu.



- When a push-button instance is identified, the icon flashes     .
- You can use the  icon to access further information.
- The  and  buttons can be used to access or hide other settings.

Different commands can be executed with one button:

- Short press of the button
- Long press of the button
- Double press of the button

### Adjustable parameters

Different functions can be set for each command:

Command	Default value	Setting values	Function
Short press of the button	ON/OFF	ON/OFF	Switch light on or off.
		ON	Switch light on.
		OFF	Switch light off.
		During the period ON	Switch on the light for a certain period of time. The desired duration can be set, e.g. [1 hour]. The subsequent behaviour depends on the operating mode. <ul style="list-style-type: none"> <li>– Fully automatic: The light stays on when motion is detected.</li> <li>– Semi-automatic: The light is switched off.</li> </ul>
		During the period OFF	Switch off the light for a certain period of time. The desired duration can be set, e.g. [1 hour]. <b>NOTE:</b> Presence detection and light control are deactivated during this period. The subsequent behaviour depends on the operating mode. <ul style="list-style-type: none"> <li>– Fully automatic: The light is switched on when motion is detected.</li> <li>– Semi-automatic: The light remains switched off.</li> </ul>
		Start scene	Access the scene with the selected scene number. The scene ends when the push-button is used to switch back to [Automatic mode]. <b>NOTE:</b> For this function, at least one scene must be created in the [Scenes] menu. For details see <i>7.9 Scenes</i> .
		Next scene	Access the scene with the next higher scene number. The desired range of scenes can be set, e.g. scene number [3 to 5]. The sequence of accessing them would then be: 3»4»5»3»4»5...
		Stop	The current lighting situation is maintained as long as presence is detected and until the follow-up time has elapsed or until you switch back to [Automatic mode] by pressing the button.
		Automatic mode	Return to the initial state.
No function	–		



Command	Default value	Setting values	Function
Long press of the button	Dim UP/DOWN	Dim UP/DOWN	When the button is pressed for the first time: Dim the light up to the maximum value; when the button is pressed again: Dim the light down to the minimum value.
		Dim UP	Dim the light up to the maximum value.
		Dim DOWN	Dim the light down to the minimum value.
		ON/OFF	(see above)
		ON	(see above)
		OFF	(see above)
		During the period ON	(see above)
		During the period OFF	(see above)
		Next scene	(see above)
		Stop	(see above)
		Automatic mode	(see above)
		No function	–
Double press of the button	Automatic mode	Automatic mode	(see above)
		Next scene	(see above)
		No function	–

NOTE: For the <Change over groups> function, **all three** button functions ([Short button press], [Long button press] and [Double button press]) must be set to [No function]. For details see *7.11 Change over groups*.

### 7.12.5 Switch

#### Description

- The push-button inputs can also be used as external switch inputs for the <Change over groups> function. For details see *7.11 Change over groups*.
- NOTE: For the push button input used, **all three** push button functions ([Short button press], [Long button press] and [Double button press]) must be set to [No function]. For details see *7.12.4 Push-button*.
- A switch in the logical sense is any electrical switch contact of a physical switch insert.
- Up to four switches can be connected to the pushbutton inputs S1-S4 of the APC with one pole.

- The number of usable switch inserts per APC depends on the design of each switch insert:

Switch insert	Contacts	Usable per APC
Single switch	1 NO contact	4 pieces
Double switch	2 NO contact	2 pieces

- The button inputs are assigned to the following switch instances of the APC:

Button input	Button instance	Switch instance
S1	0	4
S2	1	5
S3	2	6
S4	3	7

The assignment of instances may differ for other input devices (e.g. BMS detectors). For more details, please refer to the appropriate user manual.

### App

You can get to the <Switch> screen from the <Parameterise devices> menu.

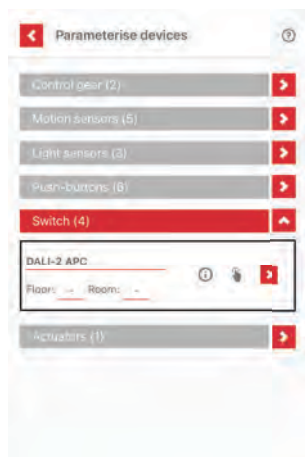

- When a switch instance is identified, the icon flashes 🖱️ 🔴 🖱️ 🔴 .
- You can use the ⓘ icon to access further information.
- The ➡️ and ⬆️ buttons can be used to access or hide other settings.

### Adjustable parameters

The following situations can be set for the switch position at the button input:

Switch position	Setting value	Effect
open	–	–
closed	Change over group ON	A <b>closed</b> switch position is passed to the <Change over group> function.
	Change over group OFF	An <b>open</b> switch position is passed to the <Change over group> function.

### 7.12.6 Actuators

#### Description

- The APC has an actuator (relay) with two-pole actuator connection K1/K2 (potential-free, max. 10 A).
- The [Actuators] function can be used for different tasks, depending on the type of component connected.
  - Relay function [Switch lighting]:  
The actuator switches depending on the light output of the control gear. The actuator switches when the current light output exceeds or falls below the switch threshold (switch-on value or switch-off value).
  - Relay function [Switch HVAC]:  
The actuator switches depending on presence detection. The switch-on delay and the follow-up time after the last presence detection can be set. Room brightness and light output are not relevant.

### App

You can get to the <Actuators> screen via the <Parameterise devices> menu.

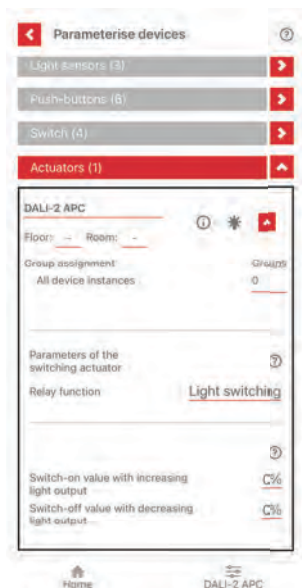

- When the actuator is identified, the icon flashes \* \* \* \* .
- You can use the ⓘ icon to access further information.
- The ▶ and ▲ buttons can be used to access or hide other settings.

### Adjustable parameters

Depending on the selected relay function, different parameters can be set:

Relay function	Connected	Parameter	Setting values	Default value
Switch lighting	230 V light or similar component	Switch-on value with increasing light output	0-100 % (in 10% steps)	0 %
		Switch-off value with decreasing light output	0-100 % (in 10% steps)	0 %
Switch HVAC	Components of heating, ventilation, air-conditioning and refrigeration technology	Switch-on delay	00:00 - 24:00	00:02
		Follow-up time	00:01 - 24:00	00:15

NOTE: When switching between relay functions, the manually set values are reset to the default values.

## **8 Projects section**

(coming soon)

## 9 Menu information

### Description



Pressing the  button opens the Information menu.

- General information and settings for the app are available in this menu.

### App

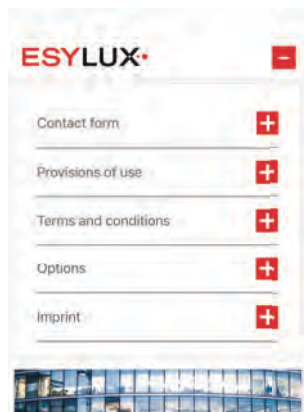

The following information and settings are available in this menu:

- **Contact form**  
This requires internet access.
  - Contact
  - Newsletter registration
  - ESYLOCATOR
- **Provisions of use**  
This requires internet access.
  - Privacy Policy
  - Disclaimer
- **Terms and conditions**  
This requires internet access.
  - Terms and conditions
  - Terms of delivery and payment

- **Options**
  - "ESYLUX internal" section
  - Current app version
- **Imprint**

This requires internet access.

  - Imprint
  - Photo credits

## 10 FAQ

### 10.1 What does this APC indicator mean?

The LED indicators of the APC that light up occasionally provide useful information.

- Various states and situations of the configuration can be identified by the colour and the flashing behaviour of the integrated LED. For details see *5.1.5 APC LED indicators*.

### 10.2 What does this app indicator mean?

The app's indicators and messages that appear in special situations provide explanation and help.

Indicator/Notification	Meaning/ Remedy/ Comment
 "No connection"	<ul style="list-style-type: none"> <li>– APC not paired with mobile device (Bluetooth).</li> <li>– APC out of Bluetooth range (10 m).</li> <li>– APC without voltage.</li> </ul>
No entries on the <Bluetooth device overview> screen	<ul style="list-style-type: none"> <li>– APC already paired with other mobile device.</li> <li>– APC out of Bluetooth range (10 m).</li> <li>– APC without voltage.</li> </ul>
Window <Bluetooth pairing request>	<ul style="list-style-type: none"> <li>– Enter the PIN code of the device.</li> </ul>
"No connection"	<ul style="list-style-type: none"> <li>– APC out of Bluetooth range (10 m).</li> <li>– APC without voltage.</li> </ul>
"No ESYLUX devices"	<ul style="list-style-type: none"> <li>– APC out of Bluetooth range (10 m).</li> <li>– APC without voltage.</li> </ul>
"Bluetooth must be enabled to use the app"	<ul style="list-style-type: none"> <li>– Bluetooth switched off on the mobile device.</li> <li>– APC without voltage.</li> </ul>
"Establishing Bluetooth connection"	<ul style="list-style-type: none"> <li>– Please wait until the connection is established.</li> </ul>
"Retrieving data from the detector"	<ul style="list-style-type: none"> <li>– Please wait until the data is synchronised (approx. 60 s).</li> </ul>
"Checking the software version"	<ul style="list-style-type: none"> <li>– Please wait until the software version has been checked.</li> </ul>
"New APC software version available"	<ul style="list-style-type: none"> <li>– The APC software can be updated.</li> </ul>
"Do not receive update notice on connection" (checkbox)	<ul style="list-style-type: none"> <li>– Check the box if the app is to be updated in the background.</li> </ul>
"Restricted offline access"	<ul style="list-style-type: none"> <li>– No internet connection. This only affects some special functions of the app, not communication with the device.</li> </ul>
"The device is already set up. [...] Exit Setup Wizard."	<ul style="list-style-type: none"> <li>– If the device is to be completely reconfigured: Reset to factory settings.</li> </ul>
"Software update ready for installation" (banner insertion)	<ul style="list-style-type: none"> <li>– Notification of the mobile device operating system (Android or iOS), referred to as "software" here.</li> </ul>



## 11 Decommissioning

### 11.1 Disassembly

To disassemble the product, work on the 230 V mains is required. This may only be carried out by electrical fitters or qualified electricians.

After disconnecting from the 230 V mains, further work can also be carried out by persons without electrical engineering qualifications.

### 11.2 Disposal

This product must not be disposed of with unsorted residual waste. Owners and operators of the product are legally obliged to dispose of all parts of the product properly and according to type:

- Electrical and electronic parts as well as cables belong to category electrical waste.
- Packaging, cardboard boxes, moulded parts and foils are in the respective material recycling category.

You can get further information from your city or municipal administration.

## 12 APPENDIX

### 12.1 Abbreviations

APC (DALI-2)	Product name
BLE	Bluetooth Low Energy: Bluetooth radio technology
BMS (DALI-2)	Product name
bt	Bluetooth
DA+/DA-, DA1/DA2	DALI-2 bus connection
ECG	Electronic control gear
FAQ	Frequently asked questions and the answers to them
GTIN	Global Trade Item Number: Identification number for trade items
HVAC	Heating, ventilation, air conditioning/refrigeration technology
K1/K2	Actuator connection (for external lighting, HVAC etc.)
LVK	Light distribution curve
lx	Lux: unit of illuminance
MD	Motion detector
OM	Operating mode
OTA	Over-the-air: radio interface (for software updates)
PD	Presence detector
PIR	Presence detector sensor technology
PS	(Bus) power supply
S1, S2, S3, S4	Push-button/switch connections
TS	Light sensor
UID	Unique Identifier: Identification number for data objects

## 12.2 Glossary

Actuator	APC relay for the connection of external components, e.g.: <ul style="list-style-type: none"> <li>– 230 V lighting</li> <li>– HVAC</li> </ul>
Address	Unique identifier of a bus device (device/instance) in the DALI-2 bus.
APC	ESYLUX term for "application controller"
Automatic light control	Lighting is controlled to a constant brightness level – depending on the amount of daylight.
Automatic mode	Push-button function: Return to the initial state of the current operating mode
BlueMode	ESYLUX term for a special configuration state of the control system
Bluetooth connection	Strictly speaking, two different techniques: <ul style="list-style-type: none"> <li>– Pairing: initial authentication.</li> <li>– Connection ("bonding"): for regular data exchange</li> </ul>
Bluetooth Low Energy (BLE)	Bluetooth technology with low power consumption
BMS	here: ESYLUX term for a presence detector general: abbreviation for building management system
Configure; Parameterise	The parameterisation of the devices is a subset of the entire configuration (devices, groups, scenes, etc.).
Control gear	DALI term for the ECG of a light
DALI; DALI-2	Interface standard/ control protocol: DALI for lighting technology, DALI-2 for building technology; DALI-2 includes DALI
Default setting, factory setting	Configuration state at delivery and after resetting the APC
Default value	Value of a parameter in the default setting
Device	here: DALI-2 component such as APC, control gear, push-button etc.
ECG	Control gear of a light
Follow-up time	Time between the last presence detection and the next control state
Group	Combination of several devices (operating and input devices); can include all or only specific lights in a room.
HVAC	here: Components of heating, ventilation, air-conditioning/ refrigeration technology
IEC 62386-xxx	Series of standards for the concept and components of DALI-2
Instance	Sub-component of a device that fulfils its own function (e.g. presence detection or brightness measurement). Each instance in the DALI-2 bus can be uniquely addressed via the device and the instance number.
Light control	Alternative to automatic light control: The lighting is switched with a predefined light output.
Manual override (by dimming)	Manual brightness setpoint adjustment: If dimming is done manually during light control, the new brightness value in the room is permanently adopted as the new brightness setpoint. Requirement: Push-button for dimming UP/DOWN is defined.

Operating mode	Control mode: fully automatic, semi-automatic (manual start) or manual only
Option; optional	Not strictly required, not included in the scope of supply of this product or only available as an accessory.
Participant, bus participant	here: Device/instance in the DALI-2 bus
Presence; motion	Literally speaking, a presence detector only detects presence, a motion detector also detects the direction of motion. In fact, it makes no difference in application.
Product	here: APC
Push-button function	Different types of push-button actuation can be interpreted by the control system: <ul style="list-style-type: none"> <li>– Short button press</li> <li>– Long button press</li> <li>– Double button press</li> </ul>
Push-button; switch	External component connected to APC, e.g.: <ul style="list-style-type: none"> <li>– Push-button for manual operation or override</li> <li>– Push-button to access scene</li> <li>– Switch for group switching</li> </ul>
Scenario	Constellation of groups
Scene	Function that can be accessed by pressing a button
Setting values	Possible range of values or selection values for a parameter
Software	here: APC Firmware





ESYLUX GmbH  
An der Strusbek 40  
22926 Ahrensburg  
Germany

Phone: +49 4102 489-0  
E-mail: [info@esylux.com](mailto:info@esylux.com)  
Internet: [www.esylux.com](http://www.esylux.com)

