

Detailed operating instructions



MD-FLAT 360i/8 RW
EP10427886



MD-FLAT 360i/8 SW
EP10427893



MD-FLAT 360i/8 RB
EP10428074



MD-FLAT 360i/8 SB
EP10428081



MD-FLAT-E 360i/8 RW
EP10428548



MD-FLAT-E 360i/8 RW GST
EP10427862



MD-FLAT-L 360i/8 RW
EP10428609





Table of contents

1	Description	3
2	Safety instructions	3
3	Operation / functionality	4
3.1	Conditions in which the lighting is switched on	4
3.2	Conditions in which the lighting is switched off	4
3.3	Switching delay – not in pulse mode	4
4	Installation / connection	5
4.1	Masking the field of detection	7
5	Activation	7
5.1	Overview of factory settings	7
6	Settings	8
6.1	Control via external “S” button	8
6.2	Configuring parameters via remote control	8
6.3	Mobil-PDi/MDi	8
6.4	Mobil-PDi/MDi temporary settings	9
6.5	Programming the Mobil-PDi/MDi	10
6.6	Mobil-PDi/MDi-universal	12
6.7	Mobil-PDi/MDi-universal temporary settings	12
6.8	Programming the Mobil-PDi/MDi-universal	13
7	Technical data	16
8	Troubleshooting	16
8.1	Maintenance	17
8.2	Cleaning	17
9	ESYLUX Manufacturer’s guarantee	18



1 Description

The ESYLUX ceiling-mounted motion detector is a passive infrared presence detector that responds to moving heat sources, such as people walking.

The motion detector is designed for areas with low levels of natural light, such as hallways, cellars, staircases, changing rooms, toilets, garages etc.

Parameters can be configured using the ESYLUX Mobil-PDi/MDi and Mobil-PDi/MDi-universal remote controls as well as via the manual setting elements.

Note: Use this product only as intended (as described in the user instructions).

The device must not be changed, modified or painted – doing so will void any warranty claims. You must check the device for damage immediately after unpacking it.

If there is any damage, you should not install the device under any circumstances.

If you suspect that safe operation of the device cannot be guaranteed, you should turn the device off immediately and make sure that it cannot be operated unintentionally.

2 Safety instructions

- **Work on the 230-V power system must be carried out by authorised personnel only, with due regard to the applicable installation regulations/standards**
- **Switch off the power supply before installing the system**
- **On the input side, the device is to be protected against short circuits with a 10-A circuit breaker**
- **Protection type IP 20 for interior use**



3 Operation / functionality

- 360° field of detection, 8-m range at an installation height of 2.5 m
- Automatically controls light channels depending on presence and daylight
- With zero-cross switching
- The setting options can vary depending on the remote control used; please see “Configuring parameters via remote control”

3.1 Conditions in which the lighting is switched on

The lighting is switched on if the target brightness value is below the preset lux value and movement is detected in the field of detection. Further movement is acknowledged by the sensor with two short flashes of the **red LED** (the LED can be switched off; see “Configuring parameters via remote control”).

3.2 Conditions in which the lighting is switched off

The lighting is switched off if no movement is detected in the field of detection and the preset switch-off delay time has elapsed.

3.3 Switching delay – not in pulse mode

When persons are present, in order to avoid sudden changes in brightness caused by undesired switching on/off of the lighting, the detector will only be triggered after a time delay.

Example: a passing cloud could potentially cause unnecessary switching.

Time delay from light to dark: 30 sec. = **red LED** lights up during this period.

Time delay from dark to light: 5 min. = **red LED** flashes during this period.



4 Installation / connection

Note: Switch off the power supply before installing the system.

- The detectors can be flush mounted and are also suitable for recessed ceiling mounting using accessories

Recessed mounting

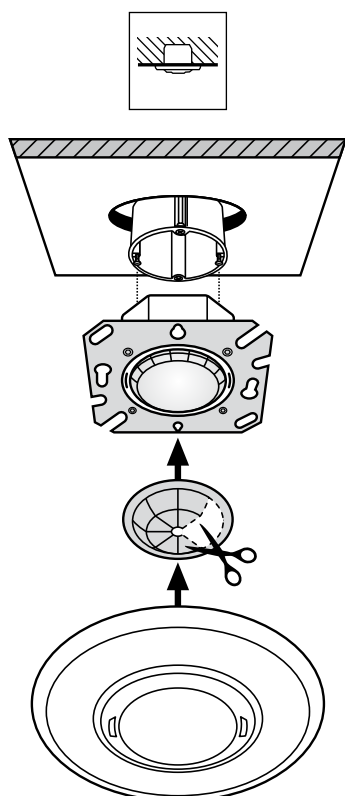

**Recessed ceiling mounting (see accessories)
for suspended ceilings**

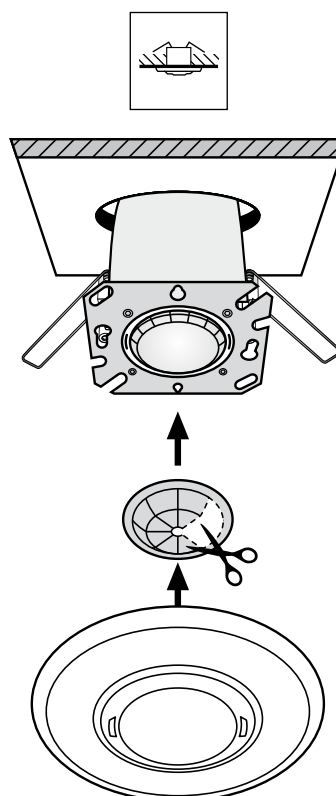



- Specifications regarding the range of the detector relate to an ambient temperature of approx. 20 °C
- Movement crossways to the detector is optimal for triggering the detector; head-on approaches to the detector are more difficult to detect and therefore the range of the detector is significantly reduced

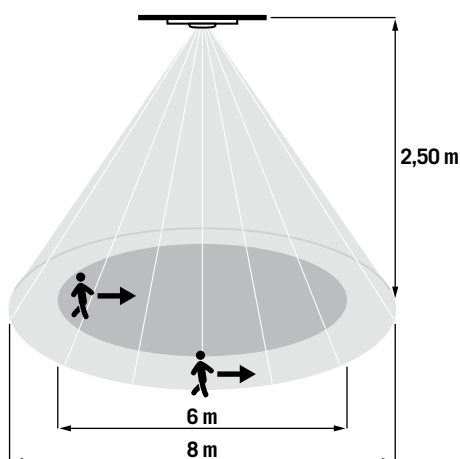

- The detector should be positioned depending on the available space and usage requirements
- Make sure that the detector has a clear line of sight, as infrared beams cannot penetrate solid objects
- Connect the detector in accordance with the circuit diagram or via the GST connector.

Single connection ————

Parallel connection - - - - -

L↑ Phase, 230 V
 L↓ Lighting
 N Neutral conductor
 S↑ Push button

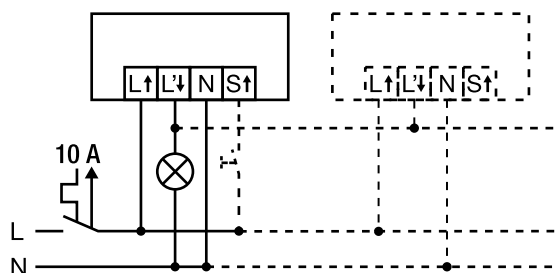



4.1 Masking the field of detection

Use the lens mask provided to mask out specific areas of detection.

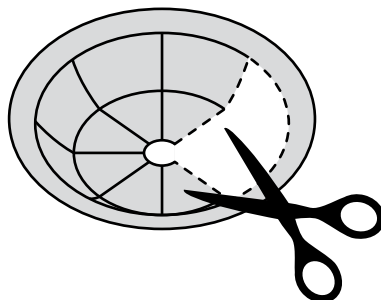

5 Activation

Connect the power supply.

A warm-up phase of 25 seconds is initiated. The **red LED** and the **blue LED** flash alternately. During this time, the lighting is switched on.

5.1 Overview of factory settings

Factory settings

Light value	approx. 100 lux
Switch-off delay time	5 min.
Sensitivity	100%
Remote control	active



6 Settings

6.1 Control via external "S" button

The ceiling-mounted motion detector is equipped with a connection for an external button (S terminal). This can be used to switch the lighting on and off manually.

Modes activated by pressing the external button:

Press button for approx. 1 second: The lighting is switched on or off (for the duration of the switch-off delay time)

Further parameters can be configured via remote control. These can be purchased as accessories.

6.2 Configuring parameters via remote control

Note: For optimum reception, when programming the settings, point the remote control at the detector. Please note that if the sensor is exposed to direct sunlight, the standard detection range of approx. 8 m may be dramatically reduced due to the sun's infrared rays.



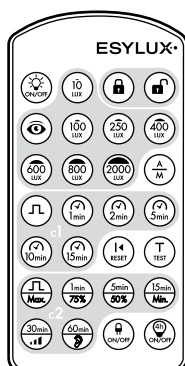

6.3 Mobil-PDi/MDi (EM10425509)





6.4 Mobil-PDi/MDi temporary settings







Parameter configurations are only temporarily applied.

Function	Customised setting
	<p>ON / OFF Switching the lighting ON/OFF manually. Note: The “ON / OFF” mode can be cancelled by pressing the “Reset” button. “ON” acknowledgement: Movement detected in the field of detection is acknowledged with two short flashes of the red LED. “OFF” acknowledgement: Movement detected in the field of detection is acknowledged with one short flash of the red LED.</p>
	<p>Reset / settings Temporarily set values are cleared and the detector returns to the manually preset operating mode.</p>
	<p>4h ON / OFF The lighting is switched on or off continuously for approx. 4 hours. If no movement is detected in the field of detection and the preset switch-off delay time has elapsed, the detector returns to the previous operating mode. Note: The “4h ON / OFF” mode can be cancelled by pressing the “Reset” button.</p>
	<p>Test Checking the range/detection using the test mode. Connected lighting turns on for clear inspection/pacing out of a detector's field of detection. Real-time, load-free indication of movement given by two flashes of the blue LED. Note: Exit test mode by pressing the “TEST” or “RESET” button again.</p>



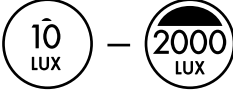





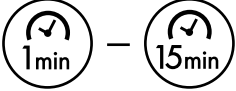

6.5 Programming the Mobil-PDi/MDi

Alterations to parameters are applied permanently.

Function	Customised setting
	<p>Enter programming mode The detector goes into programming mode. Acknowledgement: The blue LED lights up permanently and the lighting is switched on continuously.</p>
	<p>Exit programming mode The set parameters are stored on the detector. Acknowledgement: The blue LED is switched off.</p>
	<p>Set the brightness switching value, max. 2000 lux The detector switches the lighting on if the target brightness value is below the preset lux value and movement is detected in the field of detection. Acknowledgement: The red and blue LEDs flash alternately three times.</p>
	<p>The detector operates in daytime mode Light measurement is no longer active. Acknowledgement: The red and blue LEDs flash alternately three times.</p>
	<p>Take a reading of the current ambient light value The current ambient lighting level (between 5 - 2000 lux) is entered as the switch-on value. The connected lighting and the blue LED switch OFF. Once the input process has been successfully completed, the lighting switches ON and the blue LED lights up continuously.</p>
	<p>Fully automatic/semi-automatic mode The lighting can be controlled in fully automatic and semi-automatic modes.</p> <p>Fully automatic: The lighting is switched on depending on the set lux value and movement being detected. If movement is no longer detected, the preset switch-off delay time will start. The relevant active status can be optionally overridden using the external "S" button. Acknowledgement: The blue LED flashes three times.</p> <p>Semi-automatic: Control (activation of the lighting) via the external "S" button. The lighting remains switched on as long as movement is detected and the target brightness value is greater than the preset lux value. Acknowledgement: The blue LED is switched off for approx. 3 seconds.</p>



Function	Customised setting
	<p>Short pulse</p> <p>As soon as movement has been detected in the field of detection, the detector switches the lighting on for approx. 5 second and off for approx. 5 seconds. This function can be used to control automatic stairwell lights, for example.</p> <p>Acknowledgement: The red and blue LEDs flash alternately three times.</p>
 	<p>Switch-off delay time</p> <p>The switch-off delay time starts once movement is no longer detected in the field of detection.</p> <p>Acknowledgement: The red LED flashes three times.</p>
   	<p>PIR sensitivity</p> <p>Settings: maximum (100%), 75%, 50%, minimum (25%)</p> <p>The sensitivity of the detector for the purpose of detecting movement can be set.</p> <p>Acknowledgement: The red and blue LEDs flash three times.</p>
	<p>Detector LEDs ON / OFF</p> <p>The LEDs in the detector can be switched on or off.</p> <p>Acknowledgement:</p> <p>LEDs OFF: The blue LED is switched off for approx. 2 seconds.</p> <p>LEDs ON: The blue LED flashes three times.</p>
 	<p>Light level switching</p> <p>Pressing the “Programming button” three times and then pressing the “Eye button” once allows the light level measurement to be switched between ceiling mounting level and wall mounting level.</p> <p>Feedback from ceiling mounting level: The red LED in the detector lights up (factory setting).</p> <p>Feedback from wall mounting level: The green LED in the detector lights up.</p>



6.6 Mobil-PDi/MDi-universal (EP10433993)

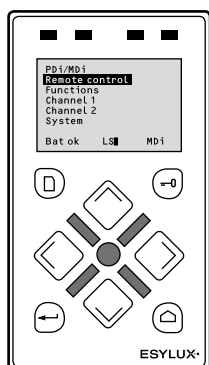

6.7 Mobil-PDi/MDi-universal temporary settings

Parameter configurations are only temporarily applied.

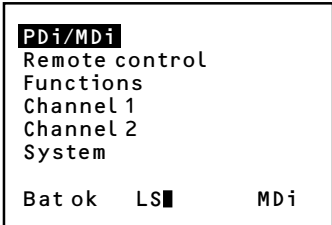
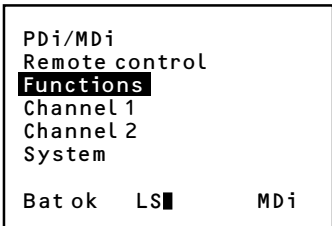
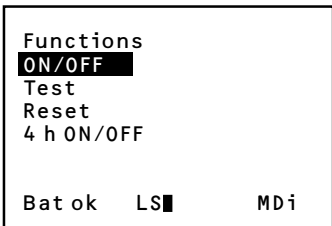
Function	Customised setting
	Selecting remote control:
	To configure temporary settings, select the sub-item “ Functions ” in the “ PDi/MDi ” menu.
	<p>ON / OFF Manual switching on/off of lighting. Note: The “4h ON / OFF” mode cannot be interrupted using the “ON / OFF” function; it can only be interrupted using the “Reset” function. “ON” acknowledgement: Movement detected in the field of detection is acknowledged with one short flash of the red LED. “OFF” acknowledgement: Movement detected in the field of detection is not acknowledged.</p>



Function	Customised setting
<pre> Functions ON/OFF Test Reset 4 h ON/OFF Bat ok LS■ MDi </pre>	<p>Reset / settings</p> <p>Temporarily set values are cleared. The detector returns to the preset operating mode.</p>
<pre> Functions ON/OFF Test Reset 4 h ON/OFF Bat ok LS■ MDi </pre>	<p>4h ON / OFF</p> <p>The lighting is switched on or off continuously for approx. 4 hours. If no movement is detected in the field of detection and the preset switch-off delay time has elapsed, the detector returns to the previous operating mode.</p> <p>Note: The “4h ON / OFF” mode can be temporarily exited using the “Reset” function.</p>

6.8 Programming the Mobil-PDi/MDi-universal

Programmed values are applied permanently.

1. Select the sub-item “**Channel 1**” in the “**PDi/MDi**” menu.

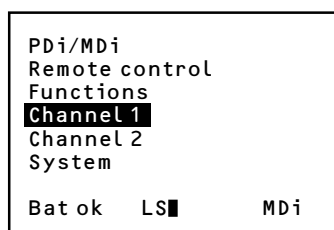



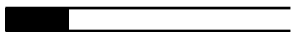
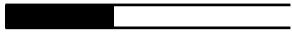

2. Then press the **(D)** button to enter programming mode.
Acknowledgement: The **red LED** lights up permanently and the lighting is switched on continuously.
3. Press the **(-0)** button to exit programming mode.
Acknowledgement: The **red LED** is switched off.



Function	Customised setting
<div style="border: 1px solid black; padding: 5px;"> Channel 1 Read-in Light Time Reset LEDs ON/OFF Fully/semi-automatic Bat ok LS■ MDi </div>	<p>Take a reading of the current ambient light value</p> <p>The detector switches the lighting on if the target brightness value is below the preset lux value and movement is detected in the field of detection.</p> <p>Acknowledgement: The blue LED and the lighting are switched off for approx. 5 seconds while the reading is taken.</p>
<div style="border: 1px solid black; padding: 5px;"> Channel 1 Read-in Light Time Reset LEDs ON/OFF Fully/semi-automatic Bat ok LS■ MDi </div>	<p>Set the brightness switching value</p> <p>Setting values: 10, 100, 250, 400, 600, 800, 2000 lux</p> <p>The detector switches the lighting on if the target brightness value is below the preset lux value and movement is detected in the field of detection.</p> <p>Acknowledgement: The red LED flashes three times in cycles if the selected brightness switching value has been confirmed using the  button.</p>
<div style="border: 1px solid black; padding: 5px;"> Light  400 Lux Bat ok LS■ MDi </div>	
<div style="border: 1px solid black; padding: 5px;"> Channel 1 Read-in Light Time Reset LEDs ON/OFF Fully/semi-automatic Bat ok LS■ MDi </div>	<p>Switch-off delay time</p> <p>Setting values: Short pulse, 1, 2, 5, 10, 15, 30 min.</p> <p>Short pulse</p> <p>As soon as movement has been detected in the field of detection, the detector switches the lighting on for approx. 5 second and off for approx. 5 seconds. This function can be used for operating automatic stairwell lights, for example.</p> <p>Acknowledgement: The red LED is switched on for 5 seconds and off for 5 seconds.</p>
<div style="border: 1px solid black; padding: 5px;"> Time  5 min Bat ok LS■ MDi </div>	<p>Switch-off delay time: 1, 2, 5, 10, 15, 30 min.</p> <p>The switch-off delay time starts once movement is no longer detected in the field of detection.</p> <p>Acknowledgement: The red LED flashes three times in cycles.</p>
<div style="border: 1px solid black; padding: 5px;"> Channel 1 Read-in Light Time Reset LEDs ON/OFF Fully/semi-automatic Bat ok LS■ MDi </div>	<p>Reset / factory settings</p> <p>The settings for the remote control are reset to the factory settings.</p> <p>Acknowledgement: The red LED flashes three times.</p>



Function	Customised setting
<div style="border: 1px solid black; padding: 5px;"> Channel 1 Read-in Light Time Reset LEDs ON/OFF Fully/semi-automatic Bat ok LS■ MDi </div>	<p>Detector LEDs ON / OFF</p> <p>The LEDs in the detector can be switched on or off by pressing the  button.</p> <p>Acknowledgement:</p> <p>LEDs OFF: The blue LED is switched off for approx. 2 seconds.</p> <p>LEDs ON: The blue LED flashes three times.</p>
<div style="border: 1px solid black; padding: 5px;"> Channel 1 Read-in Light Time Reset LEDs ON/OFF Fully/semi-automatic Bat ok LS■ MDi </div>	<p>Fully automatic / semi-automatic mode</p> <p>The lighting can be controlled in fully automatic and semi-automatic modes by pressing the  button.</p> <p>Fully automatic: The lighting is switched on depending on the set lux value and movement being detected. If movement is no longer detected, the preset switch-off delay time will start. This mode can be optionally switched on or off using the external “S” button.</p> <p>Acknowledgement: The blue LED flashes three times.</p> <p>Semi-automatic: The lighting is controlled using the external “S” button. The lighting remains switched on as long as movement is detected and the target brightness value is greater than the preset lux value.</p> <p>Acknowledgement: The blue LED is switched off for approx. 2 seconds.</p>
<div style="border: 1px solid black; padding: 5px;"> Channel 1 Read-in Light Time Reset LEDs ON/OFF Fully/semi-automatic Bat ok LS■ MDi </div>	<p>Light level switching</p> <p>Pressing the  key three times and then pressing the  button once allows the light level measurement to be switched between ceiling mounting level and wall mounting level.</p> <p>Feedback from ceiling mounting level: The red LED in the detector lights up (factory setting).</p> <p>Feedback from wall mounting level: The green LED in the detector lights up.</p>



7 Technical data

Operating voltage	230 V~ / 50-60 Hz
μ = contact opening width	$\leq 1,2$ mm
Target brightness value approx.	5 - 2000 lux
Switching capacity	2300 W / 10 A (cos φ = 1) 1150 VA / 5A (cos φ = 0,5)
Switch-off delay time	Short pulse / approx. 15 sec. - 30 min.
Protection type/protection class	IP 20 / II
Operating temperature range	0 °C ... +50 °C

8 Troubleshooting

Fault	Cause
Lighting does not switch on.	<ul style="list-style-type: none"> - Ambient light level is above the preset target brightness value - Lighting has been switched off manually - There are people in the field of detection - There are sources of thermal interference in the field of detection, such as heating, air-conditioning or moving objects (e.g. curtains by open windows) - The switch-off delay time has been set too short
Lighting is switched off during the hours of darkness despite the presence of persons	<ul style="list-style-type: none"> - Ambient light level is above the preset target brightness value - Lighting has been switched off manually
Lighting does not switch off or lighting switches on spontaneously when no persons are present.	<ul style="list-style-type: none"> - The switch-off delay time has not yet elapsed - There are sources of thermal interference in the field of detection, such as heating, air-conditioning or moving objects (e.g. curtains by open windows)
Button does not work.	<ul style="list-style-type: none"> - Device is still in the start-up phase - Illuminated button has been used without a neutral wire connection - Button is not routed to the "S terminal"
Lighting switches on and off in warm-up phase.	<ul style="list-style-type: none"> - Detector exposed to too much artificial light
Detector does not respond.	<ul style="list-style-type: none"> - Check the power supply



8.1 Maintenance

The ceiling-mounted motion detector does not contain any components that require maintenance. The device can only be replaced as a complete unit.



Note: This device must not be disposed of as unsorted household waste. Used devices must be disposed of correctly. Contact your local town council for more information.

8.2 Cleaning

No corrosive cleaning agents or solvents may be used for cleaning and care of the device. Please use a lint-free cloth that is either dry or dampened only with water.



9 ESYLUX manufacturer's guarantee

The ESYLUX manufacturer's warranty can be found online at www.esylux.com.