



**ALVA series  
Bollard light**

**Detailed operating instructions**

<b>Version</b>	<b>Date</b>	<b>Comment</b>
BA008894_00	05/10/2015	First edition
BA008894_01	23/02/2016	Chapter 3: New diagrams
BA008894_02	21.12.2022	Chapter 7: RAL 7024

© ESYLUX GmbH  
An der Strusbek 40, 22926 Ahrensburg, Germany

Details may be subject to change.

Copying is only permitted with the written consent of ESYLUX GmbH. This includes translation into other languages and reuse of content for other purposes.

## Table of contents

<b>1</b>	<b>Information about the document</b> .....	<b>4</b>
1.1	Manufacturer address .....	4
1.2	Liability and damages.....	4
1.3	Product identification .....	4
1.4	Highlighted information within the text .....	5
1.5	Warnings .....	6
<b>2</b>	<b>Basic safety information</b> .....	<b>7</b>
2.1	Intended use .....	7
2.2	Safety instructions .....	7
<b>3</b>	<b>Product description</b> .....	<b>8</b>
3.1	Mechanical set-up.....	10
3.2	Light distribution curve.....	12
3.3	Type plate .....	12
<b>4</b>	<b>Installation and connection</b> .....	<b>13</b>
4.1	Warm-up phase.....	16
4.2	Factory settings.....	17
4.3	Normal operation mode .....	17
<b>5</b>	<b>Settings</b> .....	<b>18</b>
5.1	ALVA BL.....	18
5.1.1	Switching the lighting on/off .....	18
5.2	ALVA BL with DALI interface .....	18
5.2.1	Switching light on/off and dimming lights.....	18
5.3	ALVA BL with DALI interface and motion detector .....	18
5.3.1	Switching the lighting on/off .....	19
5.3.2	Activate twilight switch .....	19
5.3.3	Setting the twilight switch value .....	20
5.3.4	Setting the switch-off delay time for lighting.....	21
5.3.5	Setting the orientation light.....	22
5.3.6	Setting the orientation light switch-off delay time.....	23
5.3.7	Fully automatic mode .....	24
5.3.8	Master circuit/slave circuit .....	25
5.3.9	Further settings via remote control .....	27
<b>6</b>	<b>Maintenance</b> .....	<b>28</b>
6.1	Cleaning.....	28
6.2	Troubleshooting.....	28

---

<b>7</b>	<b>Technical information.....</b>	<b>29</b>
<b>8</b>	<b>EC Declaration of Conformity.....</b>	<b>30</b>
<b>9</b>	<b>Disposal .....</b>	<b>30</b>
<b>10</b>	<b>ESYLUX manufacturer's guarantee.....</b>	<b>30</b>

## 1 Information about the document

These operating instructions contain detailed information about device functions and the processes for commissioning and assembling the specified devices.

This document is also available online at [www.esylux.com](http://www.esylux.com) and can be printed in A4 format.

Please read the operating instructions through in full and note all safety information and warnings.

### 1.1 Manufacturer address

#### Address

ESYLUX GmbH  
An der Strusbek 40  
22926 Ahrensburg, Germany

Website: [www.esylux.com](http://www.esylux.com)  
Email: [info@esylux.com](mailto:info@esylux.com)

### 1.2 Liability and damages

The product is designed only for the intended use, which is described in the corresponding chapter of these instructions. The device must not be changed, modified or painted — doing so will void any warranty claims.

Check the product for damage after unpacking. If the device is damaged in any way, return it to the relevant place of sale.

### 1.3 Product identification

Item number	Item designation
EL10820007	BL-ALV 20 018 830 ANT
EL10820014	BL-ALV 20 018 830 WHT
EL10820021	BL-ALV 20 018 840 ANT
EL10820038	BL-ALV 20 018 840 WHT
EL10820045	BL-ALV 20 018 830 ANO
EL10820052	BL-ALV 20 018 830 WHO
EL10820069	BL-ALV 20 018 840 ANO
EL10820076	BL-ALV 20 018 840 WHO
EL10820205	BL-ALV 20 018 830 ANT DALI
EL10820212	BL-ALV 20 018 830 WHT DALI
EL10820229	BL-ALV 20 018 840 ANT DALI

Item number	Item designation
EL10820236	BL-ALV 20 018 840 WHT DALI
EL10820243	BL-ALV 20 018 830 ANO DALI
EL10820250	BL-ALV 20 018 830 WHO DALI
EL10820267	BL-ALV 20 018 840 ANO DALI
EL10820274	BL-ALV 20 018 840 WHO DALI
EL10820403	BL-ALV 20 018 830 ANT A DALI
EL10820410	BL-ALV 20 018 830 WHT A DALI
EL10820427	BL-ALV 20 018 840 ANT A DALI
EL10820434	BL-ALV 20 018 840 WHT A DALI
EL10820441	BL-ALV 20 018 830 ANO A DALI
EL10820458	BL-ALV 20 018 830 WHO A DALI
EL10820465	BL-ALV 20 018 840 ANO A DALI
EL10820472	BL-ALV 20018840 WHO A DALI

#### 1.4 Highlighted information within the text

##### Orientation aid

To make these user instructions easier to read, certain information is highlighted by different means.

The symbols below have the following meanings:

- < > are used to highlight keys
- Grey** is used to highlight a function
- is used to highlight a call for action
- ✓ is used to highlight results of actions



Important and useful additional information on a particular topic



High level of electrical voltage

## 1.5 Warnings

Warnings are listed at the start of the relevant chapter if a hazardous situation is likely to occur.

Warnings with the signal word "DANGER" refer to scenarios that could cause personal injury. The signal word "CAUTION" indicates potential damage to property.

The signal words are described in more detail below:

### **DANGER!**

This signal word denotes a hazard involving a high level of risk. Failure to observe the warning may lead to serious or fatal injury.

---

### **WARNING!**

This signal word denotes a hazard involving a moderate level of risk. Failure to observe the warning may lead to serious or fatal injury.

---

### **ATTENTION!**

This signal word denotes a hazard involving a low level of risk. Failure to observe the warning may lead to minor or moderate injury.

---

### **CAUTION!**

This signal word warns against situations that could lead to instances of property damage if the information is not observed.

---

## 2 Basic safety information

### 2.1 Intended use

The ESYLUX ALVA BL series may only be used for the following purposes:

- For assembly outdoors by means of screwing onto a base
- The light is designed to illuminate pathways, in gardens or drive-ways, for example



To avoid potential hazards, if the external flexible lead connected to this light is damaged then it must only be replaced by the manufacturer, or by a service technician or an equally qualified individual who has been commissioned by the manufacturer.



The light contains built-in LED lamps. The light source for this light must only be replaced by the manufacturer, or by a service technician or an equally qualified individual who has been commissioned by the manufacturer.

This light is suitable for loop-in wiring. Maximum overall current of the mains terminal clamp: 10 A

The manufacturer will not accept any liability for instances of personal injury or property damage caused by improper use.

### 2.2 Safety instructions

**Specialist personnel!**

Electrical devices connected to a 230-V mains supply may only be assembled and commissioned by electrical installation technicians or trained electricians, taking country-specific regulations into account.

**⚠ DANGER!**



**Risk of fatal injury from electric shock!**

- The following five safety rules must always be observed:
  1. Disconnect the power supply
  2. Secure the power supply from being switched on again
  3. Check that the relevant components have been de-energised
  4. Set up the earthing and short-circuiting mechanisms as required
  5. Cover or isolate neighbouring live parts



**⚠ DANGER!****Risk of fatal injury from electric shock through indirect contact!**

- Safeguard the circuit with a residual current device (FI protection).
- The supply to the DALI interface is not classified as Safety Extra Low Voltage (SELV).
- There is only a single insulation method (basic insulation) between the low voltage and the DALI 1–10 V interface. The control devices that are used must guarantee appropriate protection against electric shock.

**CAUTION!****Incorrect connection will destroy the DALI electronic ballast!**

- Note the DALI specifications (IEC 62386)

### 3 Product description

**How it works**

The ESYLUX ALVA BL series is intended for outdoor use as a bollard light. The glare-free, downward-pointing light (in the case of variants with a transparent diffusor) with a 360° beam angle provides optimum illumination of pathways, such as in gardens and driveways. The beam angle can be restricted as an option with a high level of flexibility using a cover mask (available as an accessory).

The permanently installed LEDs have a low energy requirement.

The ALVA BL light is available in several versions:

**ALVA BL light**

BL-ALV xx xxx 830 xxx and BL-ALV xx xxx 840 xxx

**i** The light is controlled using external devices, such as a light switch.

**ALVA BL light with DALI interface**

BL-ALV xx xxx 830 xxx DALI and BL-ALV xx xxx 840 xxx DALI

A DALI interface (digital addressable lighting interface) built into the bollard light as an option makes it possible to receive control telegrams and simultaneously controls all of the lights connected within the DALI group.

**i** The light is controlled via the DALI interface.

Function	Benefit
<b>Switching the lighting on/off</b>	The light is switched on and off via the DALI interface.
<b>Dim lighting</b>	The brightness of the lighting is dimmed via the DALI interface.

### ALVA BL light with DALI interface and motion detector

BL-ALV xx xxx 830 xxx A DALI and BL-ALV xx xxx 840 xxx A DALI

Lights with an integrated motion detector make it possible to automate pathway lighting in line with requirements. The motion detector controls the bollard light when motion is detected, depending on the preset brightness target value. The motion detector can be used as a twilight switch.

The lights with motion detectors have a power supply for 2-pin DALI control cables (30 mA). Other DALI bus components, such as the ALVA BL lights, for example, can use approx. 16 of the 30 mA.

 The motion detector can only be set via remote control. The light is controlled via the motion detector and the DALI interface.

**With DALI interface and motion detector**

Function	Benefit
<b>Switching the lighting on/off</b>	The light is switched on and off.
<b>Motion detector function</b>	The integrated motion detector detects the movement of living beings within its detection range and switches the light on or off when lighting conditions change.
<b>Set brightness</b>	Used to set the brightness of the light.
<b>Twilight switch function</b>	Controlled exclusively on the basis of brightness target values.
<b>Set orientation light</b>	Used to provide subtle orientation lighting, e.g. in dark entrance areas.
<b>Set orientation light switch-off delay time</b>	Used to determine the switch-off delay time for the light if movement is no longer detected within the field of detection.
<b>Fully automatic mode</b>	Automatic control of the lighting when movement is detected.
<b>Master circuit/ slave circuit</b>	Expand the detection range of the motion detector.

 A detailed description of the function can be found in the "Settings" chapter on page 18

### 3.1 Mechanical set-up

#### Dimensions

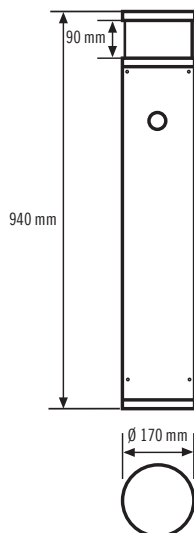

#### Components

##### Bollard light with DALI interface

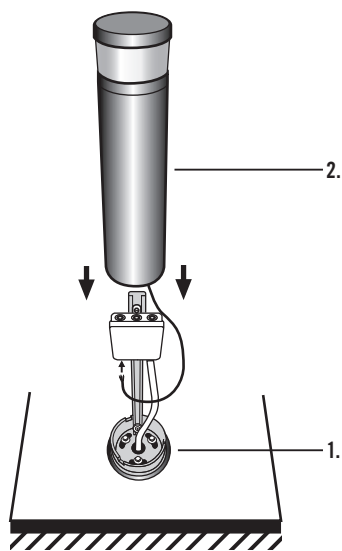

1. Mounting plate
2. Light

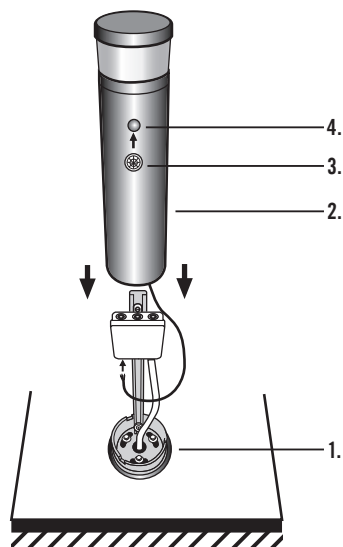
**Bollard light with DALI interface and motion detector**

1. Mounting plate
2. Light
3. Lens mask
4. Motion detectors

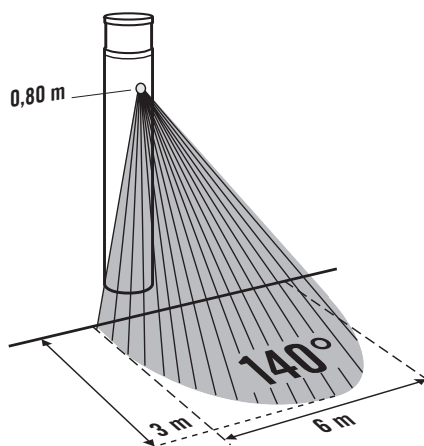
**Motion detector: Field of detection and range**

- The field of detection spans approx. 140°
- The detection range in each direction is approx. 3 m depending on the direction of movement



Lens mask for limiting the detection range

### 3.2 Light distribution curve

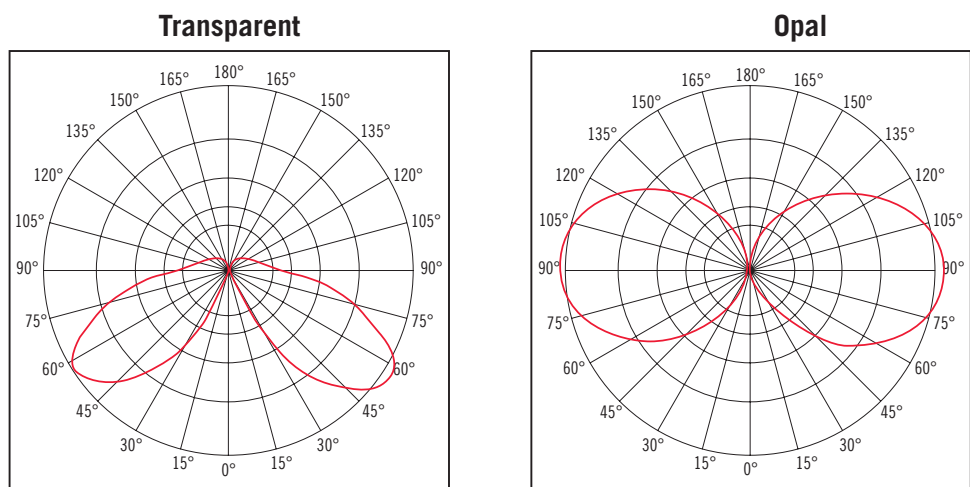

### 3.3 Type plate

Type plate features

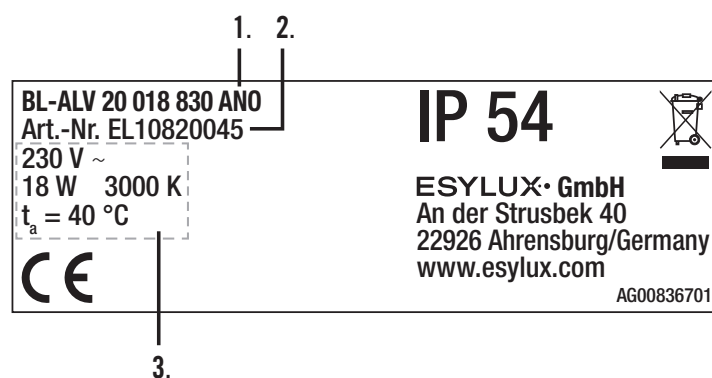

1. Designation
2. Item number
3. Technical information

## 4 Installation and connection

Proceed as follows to secure the mounting plate:

### Floor mounting

- Attach the light to the mounting plate and screw the mounting plate into place using the enclosed safety screws.

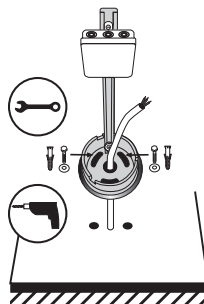

- Open the junction box and connect the mains cable and the light in accordance with the wiring diagram.

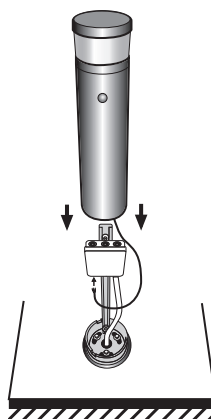

### Connection

Depending on the variant, the lights can be connected either individually or in parallel.



### **DANGER!**

**Risk of fatal injury from electric shock!**

- Switch off the power to the cable
- Check that the cable is de-energised

**ALVA BL light without motion detector**

BL-ALV xx xxx 8x0 xxx

**Proceed as follows to connect the light:**

- Connect the light as outlined in the wiring diagram.
  1. Earth conductor
  2. Neutral conductor
  3. External conductor, 230 V ~

**Connection terminals****Wiring diagram**

A maximum of 40 pollard lights can be looped through.

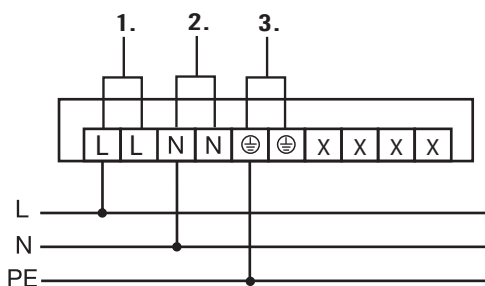
**ALVA BL light with DALI interface****ALVA BL light with DALI interface and motion detector**

BL-ALV xx xxx 8x0 xxx DALI and BL-ALV xx xxx 840 xxx A DALI

**NOTE!****Incorrect connection will destroy the DALI electronic ballasts!**

- Note the DALI specifications (IEC 62386)

**Proceed as follows to connect the light:**

- Connect the light as outlined in the wiring diagram.
  1. Earth conductor
  2. Neutral conductor
  3. External conductor
  4. DALI interface

**Connection terminals****Wiring diagram**

A maximum of 40 pollard lights can be looped through.

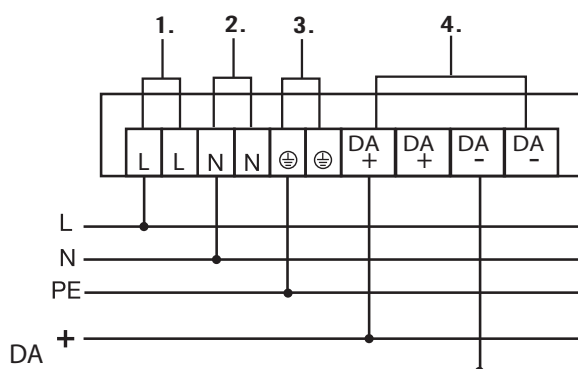
**CAUTION!****Do not reverse the polarity of the DALI connections!**

The bollard light with motion detector is equipped with a 30-mA power supply for the DALI interface. Other DALI bus components, such as the ALVA DALI BL lights, for example, can use approx. 16 of the 30 mA. The motion detector is a DALI control unit with an integrated DALI interface. There is no need to address the lights/electronic ballasts separately. All ballasts are addressed at the same time via the broadcast address.



A maximum of eight bollard lights with motion detectors can be connected in parallel to a DALI group.



### Proceed as follows to attach the light to the mounting plate:

- Position the light on the mounting plate so that the arrows are pointing towards one another.

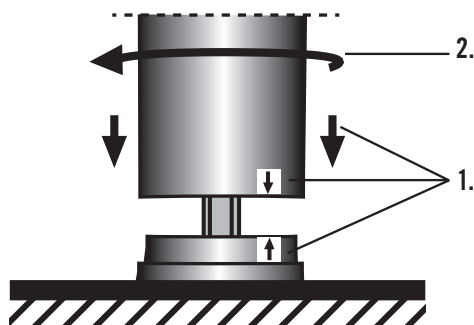

- Then turn the light in a clockwise direction and secure the lights using the enclosed safety screws.

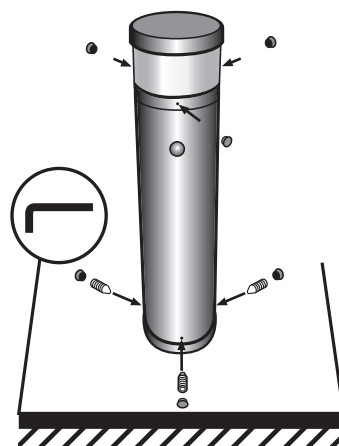

## 4.1 Warm-up phase

### With motion detector

#### Light with motion detector

The warm-up phase starts every time the power is switched on.

#### Light properties during the warm-up phase

- The light is on
- The LEDs in the motion detector flash once red, once green and once blue in alternation
- After approx. 25 seconds, the light is ready for operation and functions in line with the factory settings



Red LED = lighting channel, master circuit; green LED = slave circuit; blue LED = programming mode; yellow LED = twilight switch

## 4.2 Factory settings

### With motion detector

The factory settings for the light with integrated motion detector are as follows:

- Brightness target value: 50 lux
- Lighting switch-off delay time: 5 minutes
- Operating mode: fully automatic
- Orientation light: on (10%)
- Orientation light switch-off delay time: 1 minute
- Operating mode: master

## 4.3 Normal operation mode

In the normal operating mode, the motion detector controls the lighting depending on the lighting conditions and any movements detected.

### LED properties

#### The light switches on the lighting:

##### Prerequisites:

- The brightness target value is not exceeded

and

- The motion detector detects movement in the field of detection

#### The light switches the lighting off:

##### Prerequisites:

- The brightness target value is exceeded



The motion detector is deactivated if the brightness target value is greater than the current lighting conditions.

## 5 Settings

There are various options available for configuring and controlling the bollard light.

### 5.1 ALVA BL

#### 5.1.1 Switching the lighting on/off

The lighting is controlled using external devices, such as a light switch. Connected and disconnecting the mains power supply switches the light on/off.

### 5.2 ALVA BL with DALI interface

#### 5.2.1 Switching light on/off and dimming lights

With DALI interface

The light is controlled via the DALI interface. DALI control telegrams can trigger the functions **Switch light on/off** and **Dim light**.

### 5.3 ALVA BL with DALI interface and motion detector

In addition to control via the DALI interface, numerous settings can be made using remote control.

Mobil-PDi/Dali

The infrared remote control Mobil-PDi/Dali (item no. ep10425899) makes it possible for electrical installation technicians and users to conveniently set various parameters and special functions. This remote control is available as an accessory.



For optimum reception, point the remote control directly at the detector when programming the settings.





Please note that if the sensor is exposed to direct sunlight, the standard detection range of approx. 4 m may be reduced due to the sun's infrared rays.

### 5.3.1 Switching the lighting on/off

The light can be switched via remote control using the **Switch lighting on/off** function.

This function is only temporarily active. The detector returns to the normal operating mode if no movement is detected in the field of detection and the preset switch-off delay time has elapsed.

Function to be set	Operating steps
<b>Switch on the light</b>	<ul style="list-style-type: none"> <li>➤ Press the  button.</li> <li>✓ The light is switched on.</li> </ul>
<b>Switch off the light</b>	<ul style="list-style-type: none"> <li>➤ Press the  button.</li> <li>✓ The lighting is switched off.</li> </ul>

### 5.3.2 Activate twilight switch

The lighting is controlled automatically when the lighting conditions change using the **Activate twilight switch** function. In this mode, the motion detector functions as a twilight switch. The motion detector must have been declared as the master detector beforehand.



Details of how to declare the motion detector as the master detector can be found in the **Master circuit/slave circuit** chapter on page 27

The twilight switch can only be activated via remote control. The twilight value is preset at approx. 50 lux in the factory settings.

If lighting conditions change from dark to light, a delay period of approx. five minutes starts to prevent the light from being switched on and off multiple times.

#### Proceed as follows to switch on the lighting:



##### Prerequisite:

- The ambient light level is below the preset twilight switch value

#### Proceed as follows to switch off the lighting:





##### Prerequisite:

- The ambient light level is twice as bright as the preset twilight switch value for at least five minutes

Function to be set	Operating steps
<b>Enter programming mode</b>	<ul style="list-style-type: none"> <li>➤ Press the  button.</li> <li>✓ The blue LED lights up in the sensor head.</li> <li>✓ The lighting is switched on.</li> </ul> <p>During this time, the detector does not respond to movements.</p>
<b>Activating the twilight switch</b>	<ul style="list-style-type: none"> <li>➤ Press the  button, multiple times if necessary, until the yellow LED flashes.</li> <li>✓ The yellow LED flashes briefly three times in the sensor head.</li> <li>✓ The twilight switch is now activated.</li> </ul>
<b>Exit programming mode</b>	<ul style="list-style-type: none"> <li>➤ Press the  button.</li> <li>✓ The blue LED goes out.</li> <li>✓ The settings are saved.</li> <li>✓ The lighting goes out.</li> </ul>

### 5.3.3 Setting the twilight switch value

A fixed lux value can be set using the **Set twilight switch value** function, or the current lux value using the eye function.

Function to be set	Operating steps
<b>Enter programming mode</b>	<ul style="list-style-type: none"> <li>➤ Press the  button.</li> <li>✓ The blue LED lights up in the sensor head.</li> <li>✓ The lighting is switched on.</li> </ul> <p>During this time, the detector does not respond to movements.</p>
<b>Setting the twilight switch value</b>	<ul style="list-style-type: none"> <li>➤ Choose between the  and  buttons.</li> <li>✓ The red LED flashes briefly three times in the sensor head.</li> </ul> <p>The light sensor is deactivated during day-time operation .</p>
<b>Set current lux value for twilight switch value</b>	<ul style="list-style-type: none"> <li>➤ Press the  button.</li> <li>✓ The red LED flashes briefly three times in the sensor head.</li> </ul>

Function to be set	Operating steps
<b>Exit programming mode</b>	<ul style="list-style-type: none"> <li>➤ Press the  button.</li> <li>✓ The blue LED goes out.</li> <li>✓ The settings are saved.</li> <li>✓ The lighting goes out.</li> </ul>

### 5.3.4 Setting the switch-off delay time for lighting

The duration for which the lights remain on following the last movement can be determined using the **Set switch-off delay time for lighting** function.

This time can be set to between one minute and 30 minutes via remote control.





#### Proceed as follows to activate the switch-off delay time:

##### Prerequisites:

- The ambient light level is below the preset twilight switch value
- The light is switched on by movement
- The motion detector no longer detects any movement in the field of detection
- ✓ The switch-off delay time for the lighting duration starts



The switch-off delay time starts afresh as soon as movement is detected in the field of detection.

Function to be set	Operating steps
<b>Enter programming mode</b>	<ul style="list-style-type: none"> <li>➤ Press the  button.</li> <li>✓ The blue LED lights up in the sensor head.</li> <li>✓ The lighting is switched on.</li> </ul> <p>During this time, the detector does not respond to movements.</p>
<b>Select switch-off delay time between one and 15 minutes</b>	<ul style="list-style-type: none"> <li>➤ Choose between the  and  buttons.</li> <li>✓ The red LED flashes briefly three times in the sensor head.</li> </ul>
<b>Set switch-off delay time for 30 minutes</b>	<ul style="list-style-type: none"> <li>➤ Press the  button twice in a row.</li> <li>✓ The red LED flashes briefly three times in the sensor head.</li> </ul>

Function to be set	Operating steps
<b>Exit programming mode</b>	<ul style="list-style-type: none"> <li>➤ Press the  button.</li> <li>✓ The blue LED goes out.</li> <li>✓ The settings are saved.</li> <li>✓ The lighting goes out.</li> </ul>

### 5.3.5 Setting the orientation light

The **Set orientation light** function makes it possible to provide subtle lighting to dark surroundings. The orientation light can be set to between 10% and 20% of the maximum brightness via remote control.

#### Prerequisites:

- The **Set switch-off delay time for orientation light** function is permanently activated

#### Proceed as follows to switch on the orientation light:

##### Prerequisites:





- No movement is detected in the field of detection
- The preset switch-off delay time for the lighting has elapsed
- The ambient light level is below the set brightness target value
- ✓ The motion detector switches on the orientation light

#### Proceed as follows to switch off the orientation light:

##### Prerequisites:

- The ambient light level is above the set brightness target value
- ✓ The motion detector switches off the orientation light, despite the detected movement

Function to be set	Operating steps
<b>Enter programming mode</b>	<ul style="list-style-type: none"> <li>➤ Press the  button.</li> <li>✓ The blue LED lights up in the sensor head.</li> <li>✓ The lighting is switched on.</li> </ul> <p>During this time, the detector does not respond to movements.</p>

Function to be set	Operating steps
<b>Permanently activate the orientation light</b>	<ul style="list-style-type: none"> <li>➤ Press the  button.</li> <li>✓ The red LED flashes briefly three times in the sensor head.</li> </ul>
<b>Set orientation light between 10% and 20%</b>	<ul style="list-style-type: none"> <li>➤ Press the  button.</li> <li>✓ The red LED flashes briefly three times in the sensor head.</li> <li>✓ The light switches on to 20% of the maximum brightness</li> </ul> <p>or</p> <ul style="list-style-type: none"> <li>➤ Press the  button again.</li> <li>✓ The red LED flashes briefly three times in the sensor head.</li> <li>✓ The light switches on to 10% of the maximum brightness.</li> </ul>
<b>Exit programming mode</b>	<ul style="list-style-type: none"> <li>➤ Press the  button.</li> <li>✓ The blue LED goes out.</li> <li>✓ The settings are saved.</li> <li>✓ The lighting goes out.</li> </ul>

### 5.3.6 Setting the orientation light switch-off delay time

The **Set switch-off delay time for orientation light** function provides the option of permanently switching on the pathway lighting, or switching it on for a limited period of time.





This time can be set to between one minute and 60 minutes via remote control.

#### Proceed as follows to activate the switch-off delay time:

##### Prerequisites:

- The orientation light has been activated via remote control
- The ambient light level is below the preset twilight switch value
- No movement is detected in the field of detection
- ✓ The orientation light is switched on



Function to be set	Operating steps
<b>Enter programming mode</b>	<ul style="list-style-type: none"> <li>➤ Press the  button.</li> <li>✓ The blue LED lights up in the sensor head.</li> <li>✓ The lighting is switched on.</li> </ul> <p>During this time, the detector does not respond to movements.</p>
<b>Set the switch-off delay time for the orientation light to between one and 60 minutes</b>	<ul style="list-style-type: none"> <li>➤ Choose between the  and  buttons.</li> <li>✓ The red LED flashes briefly three times in the sensor head.</li> </ul>
<b>Permanently deactivate the orientation light</b>	<ul style="list-style-type: none"> <li>➤ Press the  button.</li> <li>✓ The red LED flashes briefly three times in the sensor head.</li> </ul>
<b>Exit programming mode</b>	<ul style="list-style-type: none"> <li>➤ Press the  button.</li> <li>✓ The blue LED goes out.</li> <li>✓ The settings are saved.</li> <li>✓ The lighting goes out.</li> </ul>

### 5.3.7 Fully automatic mode

In **Fully automatic mode**, the motion detector switches the light on and off automatically when movement is detected, depending on the preset brightness target value.

This function is activated as a factory setting.

#### The light is automatically switched on:

##### Prerequisites:

- The ambient light level is below the preset twilight value
- The motion detector detects movement in the field of detection
- ✓ The motion detector switches on the lighting



#### The light is automatically switched off:

##### Prerequisites:

- The ambient light level is above the preset brightness target value
- or
- The ambient light level is below the preset brightness target value and movement is no longer detected in the field of detection.
- The preset switch-off delay time for the lighting has elapsed

- ✓ The motion detector switches the lighting **off** or switches the orientation light **on**, if activated.

You can find more information on how to activate the orientation light in **Setting the orientation light**, page 23.

Function to be set	Operating steps
<b>Enter programming mode</b>	<ul style="list-style-type: none"> <li>➤ Press the  button.</li> <li>✓ The blue LED lights up in the sensor head.</li> <li>✓ The lighting is switched on.</li> </ul> <p>During this time, the detector does not respond to movements.</p>
<b>Activate fully automatic mode</b>	<ul style="list-style-type: none"> <li>➤ Press the  button.</li> <li>✓ The red LED flashes briefly three times in the sensor head.</li> </ul>
<b>Exit programming mode</b>	<ul style="list-style-type: none"> <li>➤ Press the  button.</li> <li>✓ The blue LED goes out.</li> <li>✓ The settings are saved.</li> <li>✓ The lighting goes out.</li> </ul>

### 5.3.8 Master circuit/slave circuit

Targeted action can be taken to expand the detection range of the motion detector using the **Master circuit/slave circuit** function. Bollard lights with motion detectors switched in parallel can be declared as the master detector or slave detector using the integrated DALI interface.

A motion detector declared as the master detector measures the level of ambient light and detects movements on an ongoing basis. The slave detector only detects movement.

If the twilight switch value is not reached, the master detector switches on the orientation light, if this light is activated. If the twilight switch value is not reached and a movement is detected, the master detector switches on the lighting.

The switch-off delay time can only be set on the master detector. For this reason, this device should be installed at the darkest point, e.g. under a tree.

If movement is detected, the slave detector sends an ON control telegram to the master detector every 30 seconds. The master detector switches the light on in the case of all DALI lights connected via the DALI bus, and the switch-off delay time starts afresh.

The master detector reads from DALI address 15; the slave detectors write to DALI address 15. The addresses are fixed and cannot be changed.

This function can only be activated via remote control.



A maximum of eight bollard lights with motion detectors can be connected in parallel to a DALI group.

### Proceed as follows to switch on the lighting:





#### Prerequisites:

- The ambient light level is below the preset twilight switch value
- ✓ The orientation light is switched on, if activated
- The slave detector or master detector detects a movement
- ✓ The master detector switches on the lights

### The switch-off delay time is extended in the following cases:

#### Prerequisites:

- The lighting is switched on
- At least one of the slave detectors or the master detector detects a movement
- ✓ The switch-off delay time starts afresh

Function to be set	Operating steps
<b>Enter programming mode</b>	<ul style="list-style-type: none"> <li>➤ Press the  button.</li> <li>✓ The blue LED lights up in the sensor head.</li> <li>✓ The lighting is switched on.</li> </ul> <p>During this time, the detector does not respond to movements.</p>
<b>Declare detector as slave</b>	<ul style="list-style-type: none"> <li>➤ Press the  button.</li> <li>✓ The green LED flashes briefly three times in the sensor head.</li> </ul>
<b>Declare detector as master</b>	<ul style="list-style-type: none"> <li>➤ Press the  button.</li> <li>✓ The red LED flashes briefly three times in the sensor head.</li> </ul>
<b>Exit programming mode</b>	<ul style="list-style-type: none"> <li>➤ Press the  button.</li> <li>✓ The blue LED goes out.</li> <li>✓ The settings are saved.</li> <li>✓ The lighting goes out.</li> </ul>





### 5.3.9 Further settings via remote control

#### LED feedback

#### Switch LEDs on/off

The LEDs integrated in the sensor head indicate the status of the motion detector. This function can be switched on/off via remote control.



The red LED flashes if movement is detected in the field of detection or if a command is received from the remote control. The blue LED lights up when the detector is in programming mode.

Function to be set	Operating steps
<b>Enter programming mode</b>	<ul style="list-style-type: none"> <li>➤ Press the  button.</li> <li>✓ The blue LED lights up in the sensor head.</li> <li>✓ The lighting is switched off.</li> </ul> <p>During this time, the detector does not respond to movements.</p>
<b>Switch off LEDs</b>	<ul style="list-style-type: none"> <li>➤ Press the  button.</li> <li>✓ The function is adopted.</li> <li>✓ The blue LED in the sensor head is deactivated for approx. three seconds.</li> </ul>
<b>Switch on LEDs</b>	<ul style="list-style-type: none"> <li>➤ Press the  button.</li> <li>✓ The function is adopted.</li> <li>✓ The blue LED in the sensor head flashes for approx. three seconds.</li> </ul>
<b>Exit programming mode</b>	<ul style="list-style-type: none"> <li>➤ Press the  button.</li> <li>✓ The blue LED goes out.</li> <li>✓ The settings are saved.</li> </ul>

#### Reset

All settings configured can be cleared using the **Reset** function. The detector reverts to the factory settings with which it was delivered.

Function to be set	Operating steps
<b>Enter programming mode</b>	<ul style="list-style-type: none"> <li>➤ Press the  button.</li> <li>✓ The blue LED lights up in the sensor head.</li> <li>✓ The lighting is switched off.</li> </ul> <p>During this time, the detector does not respond to movements.</p>

Function to be set	Operating steps
Restore factory settings	<ul style="list-style-type: none"> <li>➤ Press the  button.</li> <li>✓ The function is adopted.</li> <li>✓ The blue and red LEDs in the sensor head flash in alternation.</li> </ul>
Exit programming mode	<ul style="list-style-type: none"> <li>➤ Press the  button.</li> <li>✓ The blue LED goes out.</li> <li>✓ The settings are saved.</li> </ul>

## 6 Maintenance

The light does not contain any components that require maintenance. The device can only be replaced as a complete unit.

### 6.1 Cleaning

#### CAUTION!

Using incorrect cleaning products will damage the device!

- Use a lint-free cloth that is either dry or dampened with water.

### 6.2 Troubleshooting

#### Problem solving

Fault	Cause
Lighting is off	<ul style="list-style-type: none"> <li>• Ambient light level is above the preset twilight switch value.</li> <li>• Lighting has been switched off manually.</li> <li>• The switch-off delay time has been set too short.</li> </ul>
Lighting is switched off during the hours of darkness despite the presence of persons.	<ul style="list-style-type: none"> <li>• Ambient light level is above the preset twilight switch value.</li> <li>• Lighting has been switched off manually.</li> </ul>

Fault	Cause
Lighting does not switch off or lighting switches on spontaneously when no persons are present.	<ul style="list-style-type: none"> <li>The switch-off delay time has not yet elapsed.</li> <li>False alarm caused by pets or other environmental influences such as leaves moving in the field of detection.</li> </ul>
Detector does not respond.	<ul style="list-style-type: none"> <li>Check the power supply.</li> </ul>

## 7 Technical information

<b>Mains voltage</b>	Operating voltage	230 V AC
	Power consumption	Approx. 18 W
	In-rush current	max. 20 A
	Power consumption	Approx. 80 mA
<b>Settings</b>	Remote control	Mobil-PDi/Dali
<b>Motion detectors</b>	Switch-off delay time	approx. 1 minute – 30 minutes
	Brightness target value	approx. 10 - 1000 lux
	Orientation light	10%–20%
	Switch-off delay time, orientation light	approx. 1 minute – 60 minutes
<b>Interface</b>	BL-ALV xx xxx 8xx x DALI	DALI
<b>Colour rendering index</b>		CRI > 80
<b>Luminous flux</b>	Transparent	approx. 1150 lm
	Opal	Approx. 926 lm
<b>Beam angle</b>	Transparent	159°
	Opal	283°
<b>Light colour</b>	BI-ALV xx xxx 830	3000 K
	BL-ALV xx xxx 840	4000 K
<b>Temperature range</b>	Operating mode	-25°C ... +40°C
<b>Protection class</b>		I
<b>Protection type</b>		IP 65 (lamp head), IP 54 (socket with junction box)
<b>Terminal</b>		2.5 mm <sup>2</sup> /1.5 mm <sup>2</sup>

<b>Mains voltage</b>	Operating voltage	230 V AC
	Power consumption	Approx. 18 W
	In-rush current	max. 20 A
	Power consumption	Approx. 80 mA
<b>Dimensions</b>	Height	940 mm
	Diameter	Ø 170 mm
<b>Colour</b>	white	Similar to RAL 9016
	charcoal grey	Similar to RAL 7024

## 8 EC Declaration of Conformity

### CE declaration

The CE label corresponds to the following directives:

- EMC 2004/108/EC
- LVD 2006/95/EC
- RoHS 2011/65/EU

## 9 Disposal



This device must not be disposed of as unsorted residual waste. Used devices must be disposed of correctly. Contact your local town council for more information.

## 10 ESYLUX manufacturer's guarantee

ESYLUX manufacturer's warranty can be found online at [www.esylux.com](http://www.esylux.com).

Technical and design features may be subject to change.